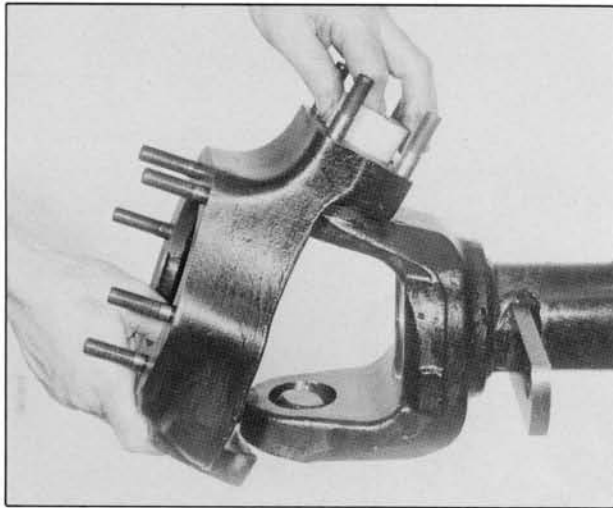


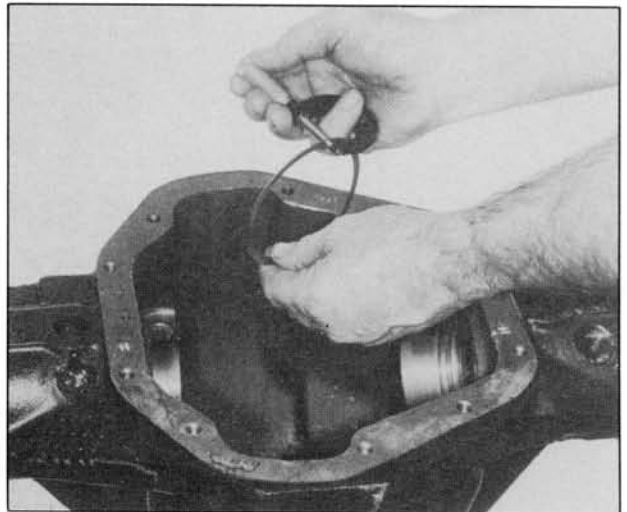
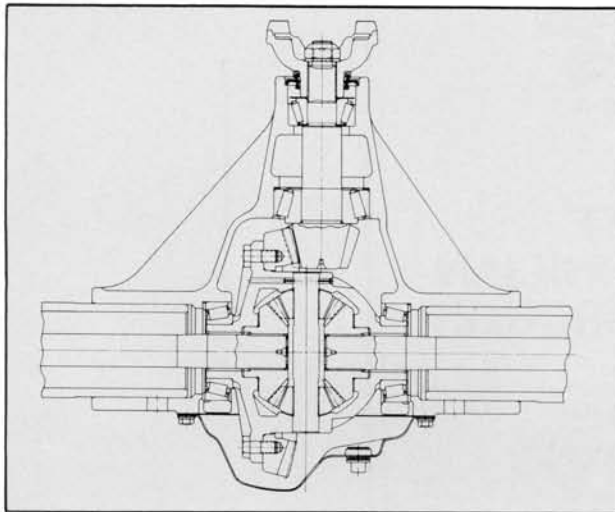
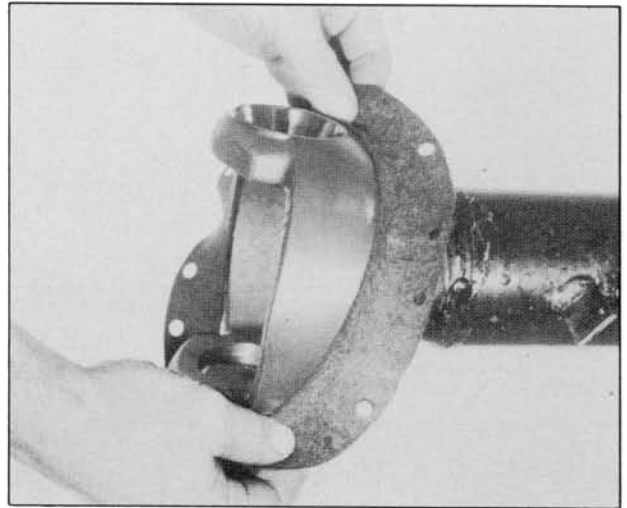
# MODEL 70

# MAINTENANCE MANUAL

**FRONT AND REAR  
CARRIER TYPE**



**AND  
HEAVY DUTY REAR**



**SPICER®**



Dana Corporation, Spicer Axle Division, reserves the right to make changes from time to time, without notice or obligations, in specifications, descriptions, and illustrations, and to discontinue models or revise designs.

Questions regarding this manual should be directed to:

Drivetrain Service Division  
Dana Corporation  
P.O. Box 321  
Toledo, OH 43691



**WE SUPPORT  
VOLUNTARY TECHNICIAN  
CERTIFICATION THROUGH**

National Institute for  
**AUTOMOTIVE  
SERVICE  
EXCELLENCE**

# INDEX

## SECTION 1 GENERAL INFORMATION

|   | PAGE |
|---|------|
| Important Safety Notice .....                         | 1-1  |
| Safety Precautions .....                              | 1-2  |
| Axle Identification .....                             | 1-3  |
| Servicing Components Not Covered In This Manual ..... | 1-4  |
| Vehicle Storage or Prolonged Inoperation .....        | 1-4  |
| Exploded View of Axle Assembly .....                  | 1-5  |
| Parts Description .....                               | 1-5  |

## SECTION 2 SERVICE TOOLS

|   |     |
|---|-----|
| Service Tool Part Numbers and Description ..... | 2-1 |
|---|-----|

## SECTION 3 WHEEL ENDS

|                               |     |
|-------------------------------|-----|
| Servicing Wheel Ends          |     |
| Closed Ball Yoke Design ..... | 3-1 |
| Assembly .....                | 3-4 |
| Open Yoke Design .....        | 3-7 |
| Assembly .....                | 3-9 |

## SECTION 4 CARRIER SECTION - SERVICE PROCEDURES

|  |      |
|--|------|
| Disassembly .....  | 4-1  |
| Ring Gear Removal .....  | 4-2  |
| Servicing Standard Differential Case Assembly                    |      |
| Two Piece Design .....   | 4-2  |
| One Piece Design .....   | 4-4  |
| Drive Pinion Removal .....                                       | 4-5  |
| Ring Gear & Pinion Gear Assembly Theory .....                    | 4-7  |
| Establishing Pinion Gear Depth Using Special Service Tools ..... | 4-8  |
| Assembly of Differential .....                                   | 4-13 |

|  |             |
|--|-------------|
| <b>Worksheet for Calculating Ring Gear Backlash &amp; Differential</b> |             |
| <b>Bearing Preload Shims</b> .....                                     | <b>4-15</b> |
| <b>Torque to Rotate Example for a 4.10:1 Gear Set</b> .....            | <b>4-16</b> |
| <b>Applying RTV Silicone Gasket Sealer to Cover Plate</b> .....        | <b>4-17</b> |

## **SECTION 5 SPECIFICATIONS**

|  |            |
|--|------------|
| <b>Differential Lubrication</b> .....                      | <b>5-1</b> |
| <b>Limited Slip Differential Lubrication</b> .....         | <b>5-1</b> |
| <b>Wheel Bearing Lubrication</b> .....                     | <b>5-1</b> |
| <b>Closed Wheel End Steering Knuckle Lubrication</b> ..... | <b>5-1</b> |
| <b>Axle Lubricant Change Schedule</b> .....                | <b>5-1</b> |
| <b>Submersion or Deep Water Fording</b> .....              | <b>5-2</b> |
| <b>RTV Silicone Rubber Sealer Specification</b> .....      | <b>5-2</b> |
| <b>Fastener Strength Identification</b> .....              | <b>5-2</b> |
| <b>Wrench Tightening Torque Specifications</b> .....       | <b>5-3</b> |
| <b>Pinion Bearing and Differential Bearing</b>             |            |
| <b>Preload Specification</b> .....                         | <b>5-3</b> |
| <b>Backlash Specification</b> .....                        | <b>5-3</b> |
| <b>Drive Pinion Gear Depth Specification</b> .....         | <b>5-3</b> |



# SECTION 1

## GENERAL INFORMATION

### IMPORTANT SAFETY NOTICE

Should an axle assembly require component parts replacement, it is recommended that "Original Equipment" replacement parts be used. They may be obtained through your local service dealer or other original equipment manufacturer parts supplier. **CAUTION: THE USE OF NON-ORIGINAL EQUIPMENT REPLACEMENT PARTS IS NOT RECOMMENDED AS THEIR USE MAY CAUSE UNIT FAILURE AND/OR AFFECT VEHICLE SAFETY.**

Proper service and repair is important to the safe, reliable operation of all motor vehicles or driving axles whether they be front or rear. The service procedures recommended and described in this service manual are effective methods for performing service operations. Some of these service operations require the use of tools specially designed for the purpose. The special tool should be used when and as recommended.

**CAUTION: EXTREME CARE SHOULD BE EXERCISED WHEN WORKING ON COMPONENTS UTILIZING SNAP RINGS OR SPRING LOADED RETENTION DEVICES. FOR PERSONAL SAFETY, IT IS RECOMMENDED THAT INDUSTRIAL STRENGTH SAFETY GOGGLES OR GLASSES BE WORN WHENEVER REPAIR WORK IS BEING DONE ON ANY VEHICLE OR VEHICLE COMPONENTS.**

It is impossible to know, evaluate and advise the service trade of all conceivable ways in which service might be done or of the possible hazardous consequences of each way. Accordingly, anyone who uses a service procedure or tool which is not recommended must first satisfy himself thoroughly that neither his safety or vehicle safety will be jeopardized by the service methods he selects.

#### WARNING

Some vehicle manufacturers may require the assembly of brake components on Dana axles that utilize materials containing asbestos fibers.

**BREATHING ASBESTOS DUST MAY BE HAZARDOUS TO YOUR HEALTH AND MAY CAUSE SERIOUS RESPIRATORY OR OTHER BODILY HARM.**

Follow O.S.H.A. standards for proper protective devices to be used when working with asbestos materials.

#### SILICONE RUBBER SEALANT (RTV) AND LUBRICATING GREASE AND OILS

Silicone rubber sealant is used as a gasket material on Dana axles, as well as various lubricants for lubricating purposes. Before using any of these materials, one should become familiar with and follow all safety precautions as recommended by the product manufacturer/supplier. All personnel involved with these materials should follow good industrial hygiene practices (e.g. before eating, hands and face should be thoroughly washed. Eating, drinking and smoking should be prohibited in areas where there is potential for significant exposure to these materials).

When discarding any of the materials, observe all local, state, and federal laws and regulations for proper disposal procedures.

# Safety Precautions



This symbol warns of possible personal injury.



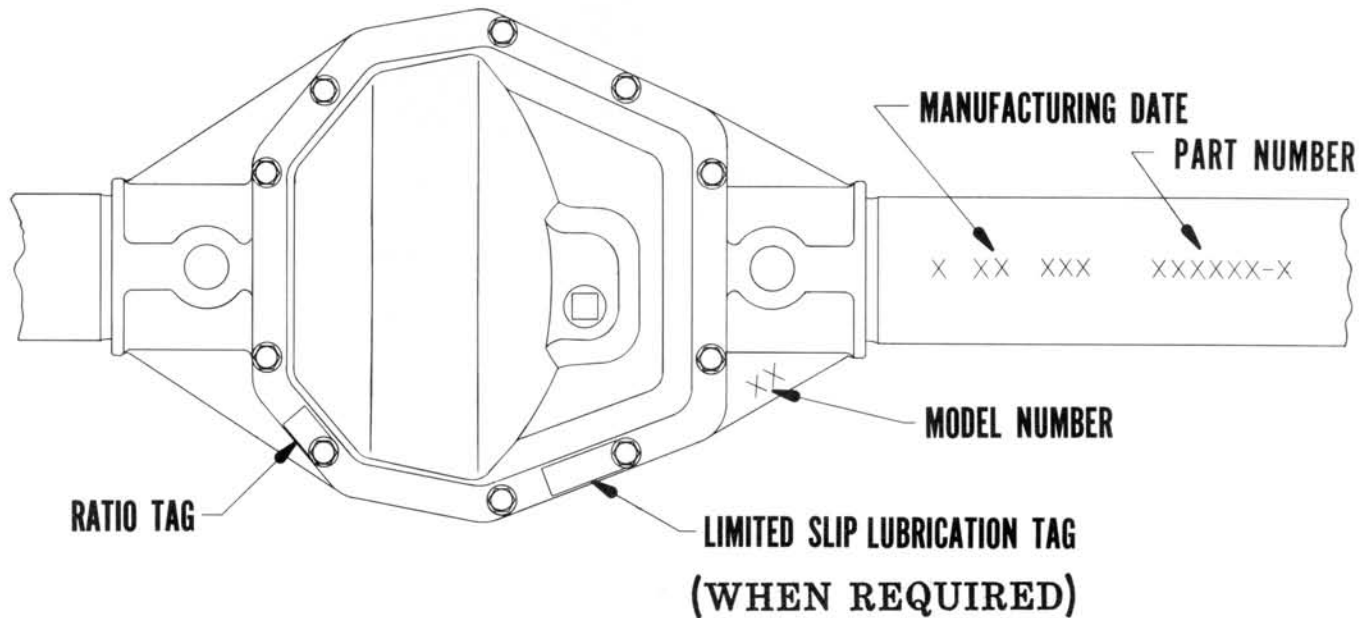
A serious or fatal injury can occur...

- if you lack proper training
- if you fail to follow proper procedures
- if you do not use proper tools and safety equipment
- if you assemble components improperly
- if you use incompatible components
- if you use worn-out or damaged components
- if you use components in a non-approved application



**SAFETY GLASSES SHOULD BE WORN AT ALL TIMES WHEN WORKING ON VEHICLES OR VEHICLE COMPONENTS.**

## AXLE IDENTIFICATION



**Figure 1-1**

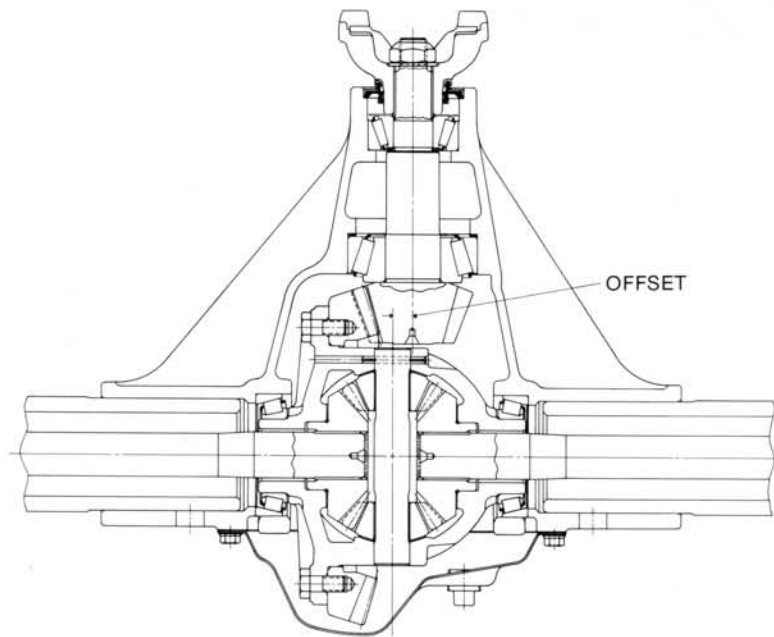
Spicer Axles are identified with a manufacturing date and complete part numbers stamped on the right-hand or longest tube. The part number may also appear on a metal tag attached to the cover plate by the cover screws, depending upon the requirements of the vehicle manufacturer.

The first group of numbers is the manufacturing date and is interpreted as follows. The first number is the month, the second number is the day, the third number is the year, the fourth number is the assembly line that built the axle, and the letter is the shift. The part number, consisting of six digits identifying the basic axle assembly and a dash number identifying ratio, differential, and end yoke options, is needed to properly identify a Spicer Axle.

### NOTE

It is recommended that when referring to the axle, the complete part number and build date be obtained. To do this, it may be necessary to wipe or scrape off dirt, etc., from the axle housing.

If the axle is unique on design such that the unit cannot be identified in the standard manner as described above, refer to the vehicle manufacturer's service and/or parts manual for proper identification.



**Figure 1-2**

Model 70 front and rear axles can be classified by three groups of pinion offset. The pinion offset is defined as the distance between the pinion centerline and the differential case centerline. The following chart describes various models of axles and the approximate model years of production.

| MODEL  | OFFSET | APPROXIMATE MODEL YEARS OF PRODUCTION |
|--------|--------|---------------------------------------|
| 70     | .500"  | very late 1950's to 1971              |
| 70-B   | .625"  | 1971 to 1982                          |
| 70-U   | .625"  | 1982 to current*                      |
| 70-HD  | .625"  | 1968 to current*                      |
| 70-3HD | .969"  | 1987 to current*                      |

\*at time of publication

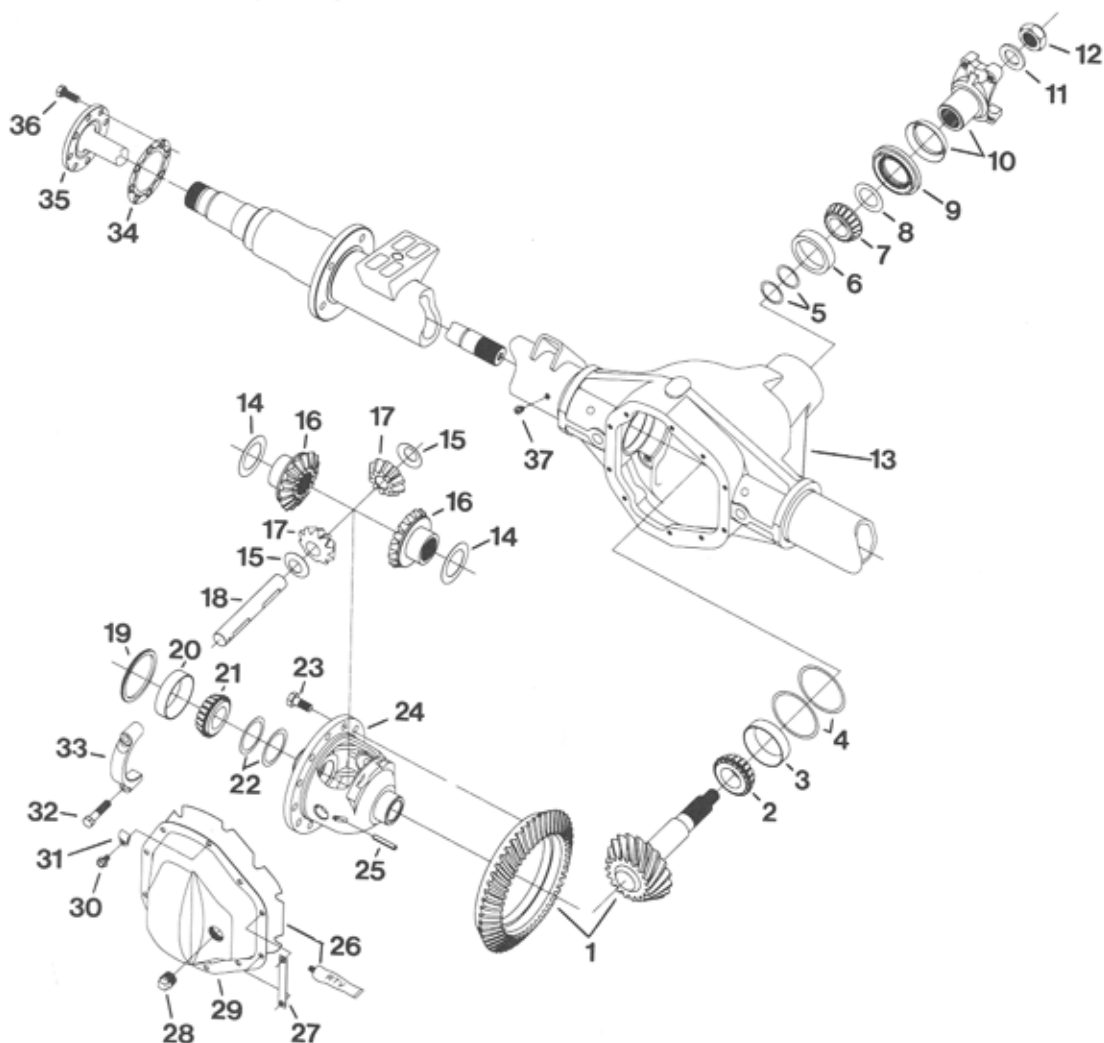
## SERVICING COMPONENTS NOT COVERED IN THIS MANUAL

Service procedures for some components may not be covered in this manual because they are unique to the vehicle application. Refer to the vehicle manufacturer's service manual for servicing those components. (e.g. brakes, hubs, rotors, and wheel end components.)

## VEHICLE STORAGE OR PROLONGED INOPERATION

If the vehicle has not been operated on a regular daily basis, it is recommended that the vehicle be operated at least once every two weeks. The vehicle should be moved far enough to cause the drivetrain components to make several complete revolutions. This procedure will help assure that all internal components receive adequate amount of lubrication to help reduce component deterioration caused by an undesirable environment (e.g. high humidity).

## EXPLODED VIEW OF AXLE ASSEMBLY



**Figure 1-3**

The Model 70 axle assembly is an integral-type housing. Shown in Figure 1-3 is a Model 70 full-float design rear axle.

| Item | Part Description                          | Item | Part Description                                 |
|------|---|------|--|
| 1    | Ring Gear and Pinion Assembly             | 20   | Differential Bearing Cup                         |
| 2    | Inner Pinion Bearing Cone                 | 21   | Differential Bearing Cone                        |
| 3    | Inner Pinion Bearing Cup                  | 22   | Differential Bearing Preload and Backlash Shims  |
| 4    | Pinion Position Shims                     | 23   | Ring Gear Screw                                  |
| 5    | Pinion Preload Shims (may include spacer) | 24   | Differential Case                                |
| 6    | Outer Pinion Bearing Cup                  | 25   | Roll Pin (Pinion Mate Shaft)                     |
| 7    | Outer Pinion Bearing Cone                 | 26   | RTV Sealant                                      |
| 8    | Thrust Washer                             | 27   | Identification Tag (on some models)              |
| 9    | Pinion Seal                               | 28   | Fill Plug  |
| 10   | End Yoke and Flinger Assembly             | 29   | Cover Plate                                      |
| 11   | Washer                                    | 30   | Cover Screw                                      |
| 12   | Nut                                       | 31   | Brake Line Clip (on some models)                 |
| 13   | Housing                                   | 32   | Differential Bearing Cap Screw (Part of Housing) |
| 14   | Side Gear Thrust Washer                   | 33   | Differential Bearing Cap (Part of Housing)       |
| 15   | Pinion Mate Gear Thrust Washer            | 34   | Axle Shaft Flange Gasket                         |
| 16   | Differential Side Gear                    | 35   | Axle Shaft                                       |
| 17   | Differential Pinion Mate Gear             | 36   | Axle Shaft Screw                                 |
| 18   | Differential Pinion Mate Shaft            | 37   | Vent   |
| 19   | Differential Outboard Spacer (if used)    |      |  |

## SECTION 2

# SERVICE TOOLS

Throughout this manual reference is made to certain tool numbers whenever special tools are required. These tool numbers are numbers of Miller Special Tools, 32615 Park Lane, Garden City, MI 48135. They are used herein for customer convenience only. Dana makes no warranty or representation to these tools.

| Miller Tool Number | Description   |
|--------------------|---|
| D-128              | Dial Indicator Set  |
| D-131              | Slide Hammer  |
| C-452              | End Yoke Remover  |
| C-3718             | End Yoke Installer  |
| D-167              | Spreader  |
| D-163              | Pinion Seal Installer (National)                                      |
| D-164              | Pinion Seal Installer (Chicago Rawhide)                               |
| C-3281             | End Yoke Holding Wrench   |
| C-4171             | Universal Handle  |
| D-159              | Remover-Inner Pinion Bearing Cup<br>70, 70-B, 70-HD, 70-3HD           |
| D-162              | Remover-Inner Pinion Bearing Cup 70-U                                 |
| C-4204             | Installer-Inner Pinion Bearing Cup<br>70, 70-B, 70-HD, 70-3HD         |
| D-111              | Installer-Inner Pinion Bearing Cup<br>70-U                            |
| DD-914-95          | Adapters-Inner Pinion Bearing Cone Removal<br>70, 70-B, 70-HD, 70-3HD |
| C-293-37           | Adapters-Inner Pinion Bearing Cone Removal<br>70-U                    |
| C-3095-A           | Installer-Inner Pinion Bearing Cone                                   |
| DD-914-62          | Adapters-Differential Bearing Cone Removal<br>70, 70-B, 70-U          |
| D-914-99           | Adapters-Differential Bearing Cone Removal<br>70-HD, 70-3HD           |
| C-4025             | Installer-Differential Bearing Cone<br>70, 70-B, 70-U                 |
| C-4190             | Installer-Differential Bearing Cone<br>70-HD, 70-3HD                  |
| D-158              | Remover-Outer Pinion Bearing Cup                                      |
| C-4203             | Installer-Outer Pinion Bearing Cup                                    |
| DD-914-P           | Press   |
| DD-914-7           | Extension   |
| DD-914-8           | Adapter Ring  |
| DD-914-9           | Adapter Ring  |
| DD-914-42          | Button  |
| D-115-2            | Scooter Gage  |
| D-137              | Master Pinion Block<br>70, 70-B, 70-HD, 70-3HD                        |
| D-120              | Master Pinion Block 70-U  |
| D-116-1            | Pinion Height Block   |
| D-115-3            | Arbor   |
| D-116-2-70         | Arbor Discs 70, 70-B, 70-U  |
| D-116-2-70-HD      | Arbor Discs 70-HD, 70-3HD   |
| D-343 (D-117)      | Master Differential Bearings (two per set)<br>70, 70-B, 70-U          |

**Miller Tool Number (cont.)****Description (cont.)**

|               |   |
|---------------|---|
| D-346 (D-136) | Master Differential Bearings (two per set)<br>70-HD, 70-3HD |
| D-160         | Installer-Front Axle Differential Oil Seals                 |
| D-166         | Fixture-Differential Case Holding                           |
| D-141         | Installer-Front Spindle Bushing                             |
| D-161         | Installer-Closed Ball Spindle Bushing                       |
| D-258         | Installer-Front Spindle Needle Bearing                      |
| D-142         | Installer-King Pin Bearing Cup                              |
| D-192         | Installer & Remover-King Pin Upper Ball Joint<br>Pivot Stud |
| D-194         | Installer-Steering Knuckle Lower Bearing Seal               |
| C-4809        | Torque Wrench (0-50 lbs.-in.)                               |
| C-524-A       | Torque Wrench (0-100 lbs.-ft.)                              |
| DA-4600-FM    | Torque Wrench (0-600 lbs.-ft.)                              |

## SECTION 3

### WHEEL ENDS

#### SERVICING WHEEL ENDS — CLOSED BALL YOKE DESIGN

Refer to Vehicle Manufacturer's recommendations for servicing brakes, wheel bearings, seals and other wheel end components not covered by this manual.

##### NOTE

The photos or pictures contained herein are for illustrative and instructional purposes only. The appearance of your axle assembly and/or components may vary from that shown. However, the service procedures described will apply.

##### WARNING

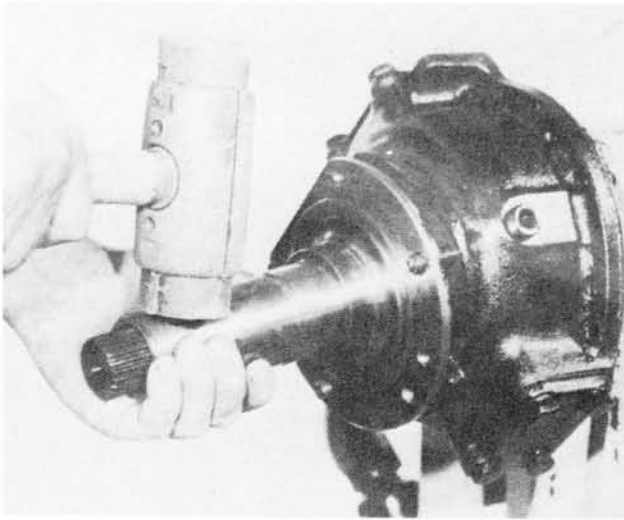


Some vehicle manufacturers may require the assembly of brake components on Dana axles that utilize materials containing asbestos fibers.

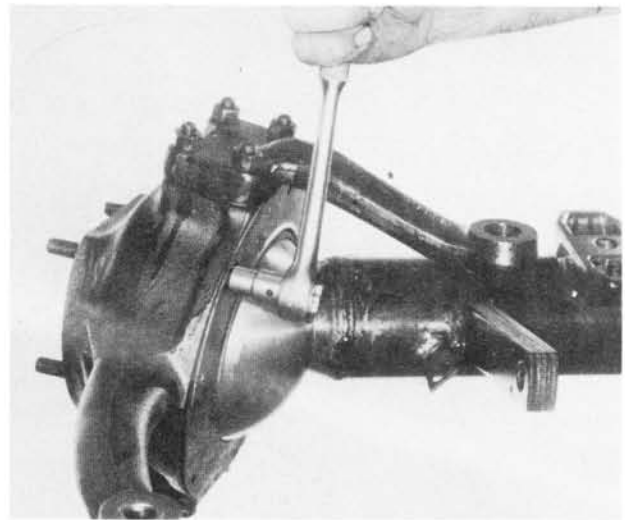
**BREATHING ASBESTOS DUST MAY BE HAZARDOUS TO YOUR HEALTH AND MAY CAUSE SERIOUS RESPIRATORY OR OTHER BODILY HARM.**

Follow O.S.H.A. standards for proper protective devices to be used when working with asbestos materials.

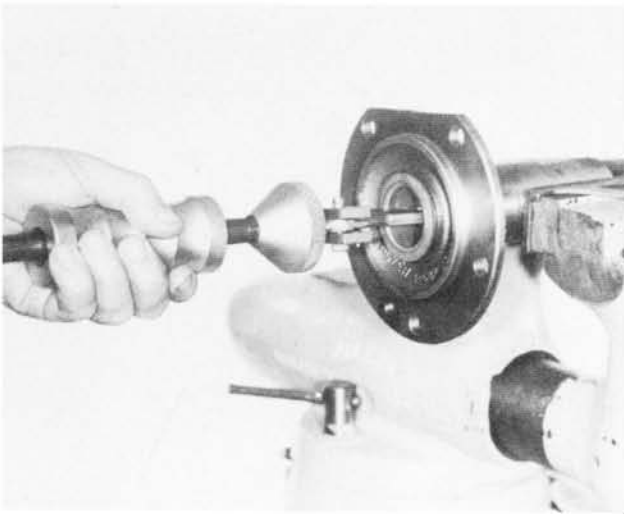




**Figure 3-1**  
Remove spindle. Tap lightly with a rawhide hammer to break the spindle loose from the knuckle.



**Figure 3-3**  
Remove twelve cap screws, two retainer plates, felt seal, and oil seal. Discard retainer plates, felt seal and oil seal. Replace with new ones at time of assembly.



**Figure 3-2**  
Place spindle in vise. **DO NOT LOCATE ON BEARING DIAMETER.**

**NOTE**

Be sure that vise jaws are equipped with brass protectors or similar type to protect the machined surfaces that are to be placed in the vise.

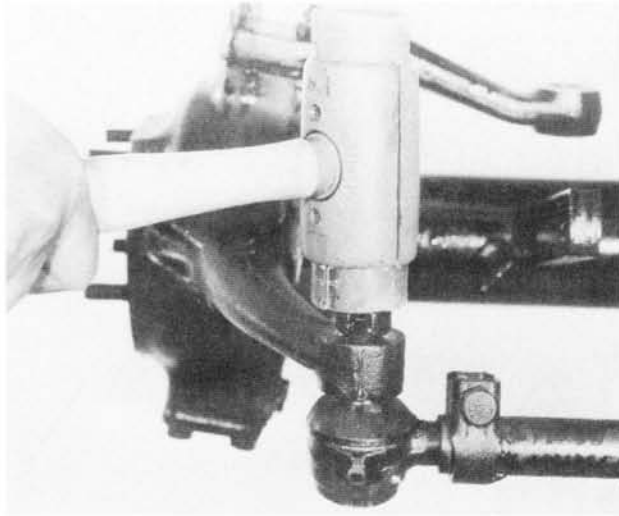
Remove bronze bushing with a slide hammer puller.

TOOL: D-131 Slide Hammer

Remove axle shaft and joint assembly.

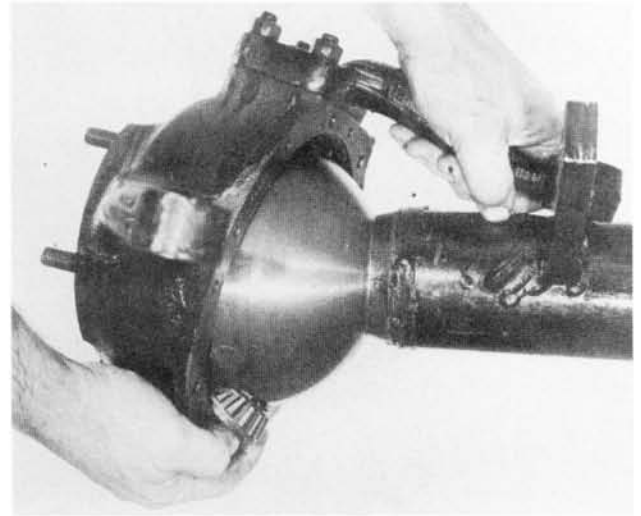


**Figure 3-4**  
Cut felt in half to disassemble. Discard felt seal.



**Figure 3-5**

Loosen tie rod nut until flush with end of the stud. Strike sharply on top of nut using a rawhide hammer until tie rod stud becomes free from steering arm. Remove nut and remove tie rod.

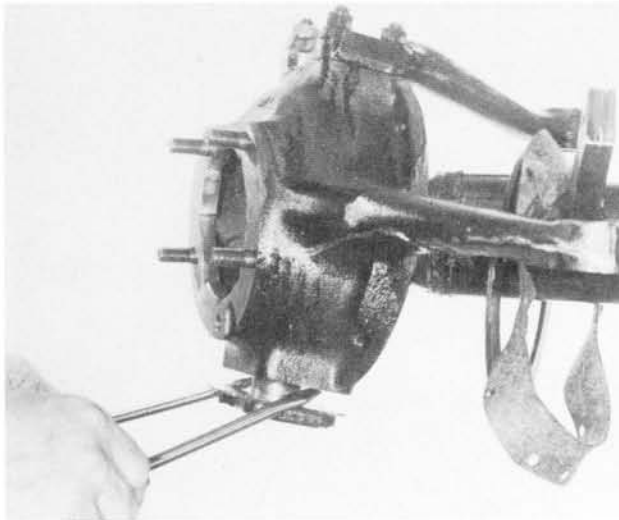


**Figure 3-7**

Remove knuckle from ball yoke.

**CAUTION**

The bottom bearing cone will fall out as the knuckle is being removed. To prevent damage to the bearing from falling to the ground, catch it with hand.



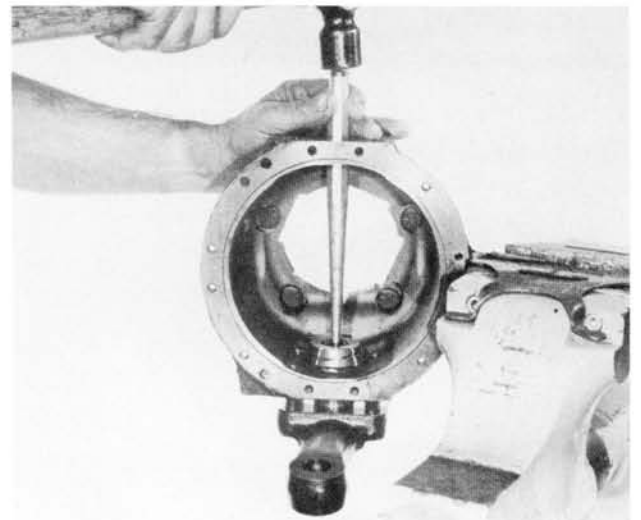
**Figure 3-6**

Remove four cap screws from the bottom bearing cap. Use a screwdriver to loosen the bearing cap from the knuckle.

**NOTE**

King pin bearing preload shims are located between the bottom bearing cap and knuckle. Wire shims together as they will be used during assembly. Shims may stick to either the knuckle or bearing cap. Be sure you have them all collected.

Shims are available in thicknesses of .003, .005, .010 and .030 in. (.08, .13, .25 and .76 mm).



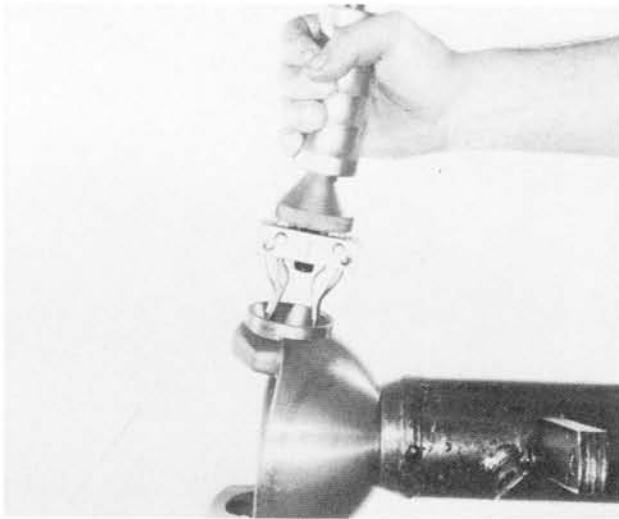
**Figure 3-8**

Place knuckle in vise as shown, and remove the top bearing cap nuts.

Remove steering arm. Use hammer and drift as shown to disassemble arm from knuckle and bronze bearing. Discard the woodruff key which is in the king pin. Replace with new one during assembly.

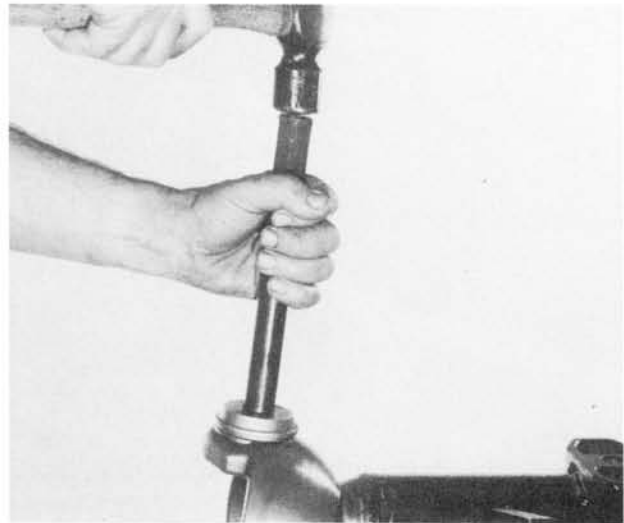
**NOTE**

There is a constant shim pack of .060 in. (1.5 mm) between the steering arm bearing cap and knuckle. This pack is to be saved and **replaced during assembly**.

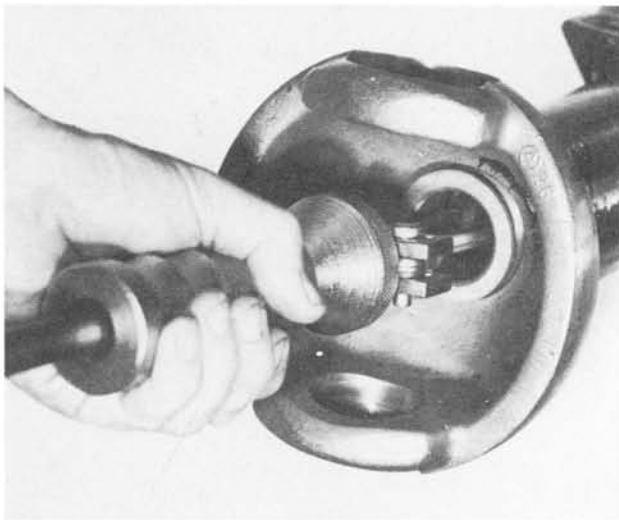


**Figure 3-9**  
Remove king pin bearing cups from spherical ball; use puller as shown.  
TOOL: D-131 Slide Hammer

## ASSEMBLY



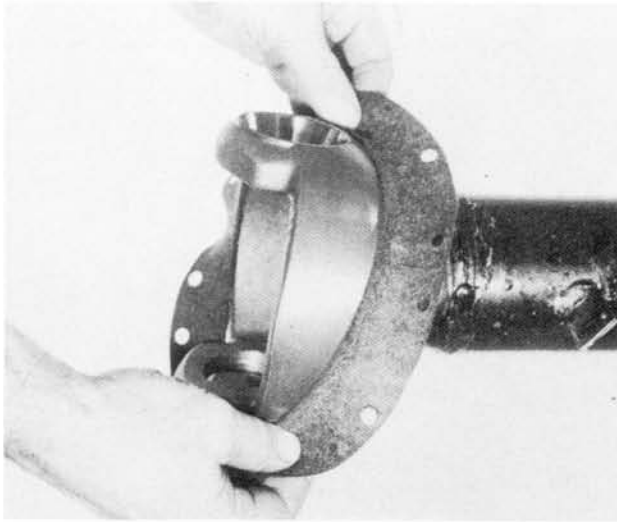
**Figure 3-11**  
Assemble new king pin bearing cups into spherical ball. Use tool as shown.  
TOOLS: D-142 Installer  
D-4171 Handle



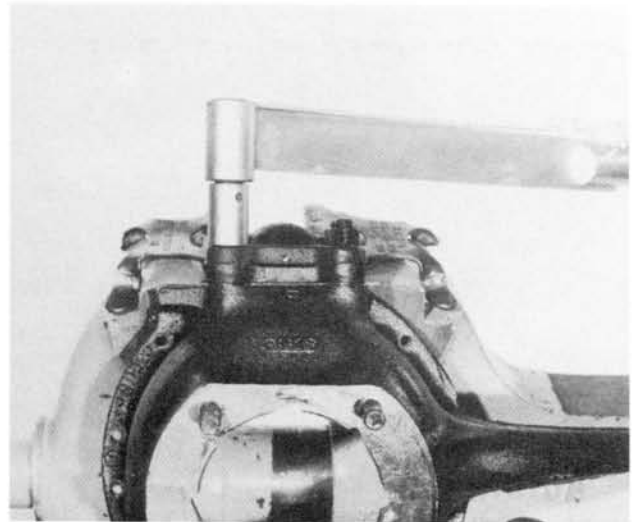
**Figure 3-10**  
Remove bronze bushing from ball yoke.  
TOOL: D-131 Slide Hammer



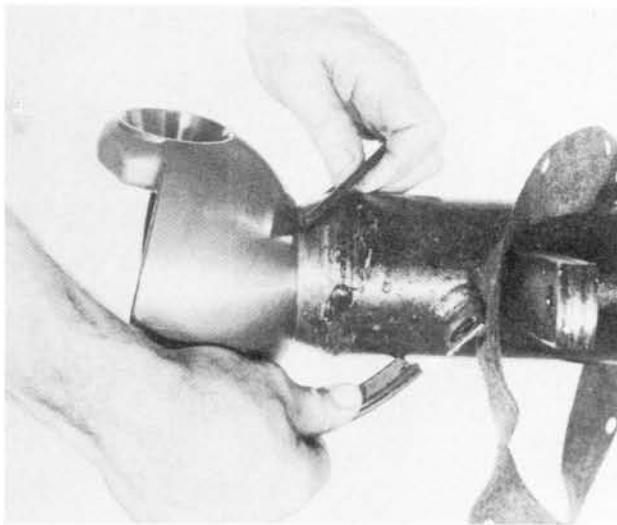
**Figure 3-12**  
Assemble new bronze bushing into ball yoke.  
TOOLS: D-161 Installer  
C-4171 Handle



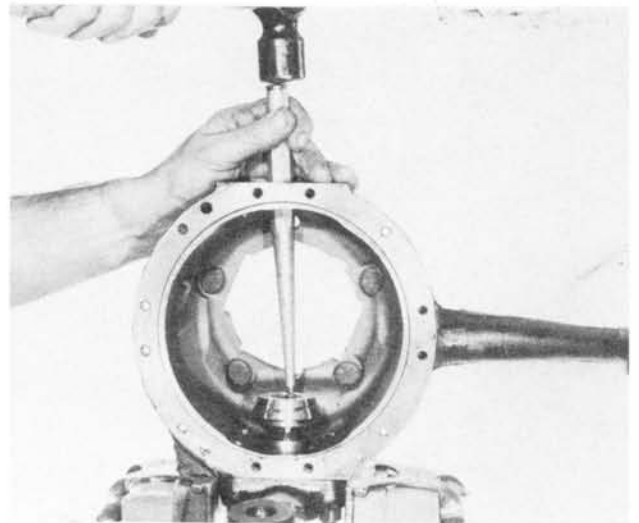
**Figure 3-13**  
Assemble new felt on the spherical ball as shown.



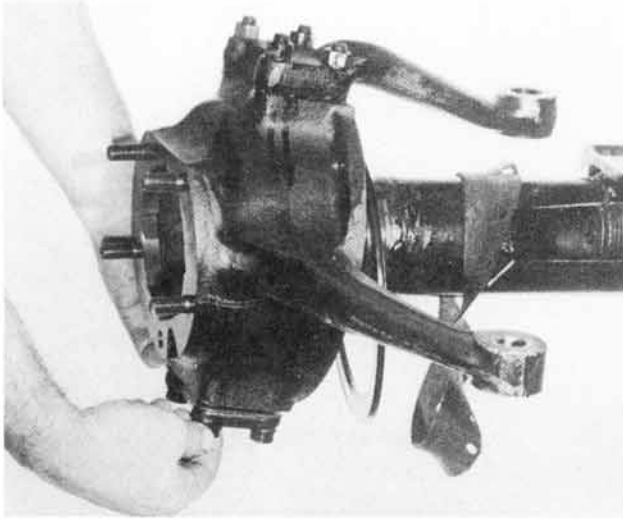
**Figure 3-15**  
Locate knuckle in vise and assemble shim pack and steering arm and bearing cap assembly to knuckle. Torque nuts to specification.



**Figure 3-14**  
Assemble new oil seal with the metal part of the seal towards the end of the axle. Spread split of seal just enough to slip over the tube of the axle.



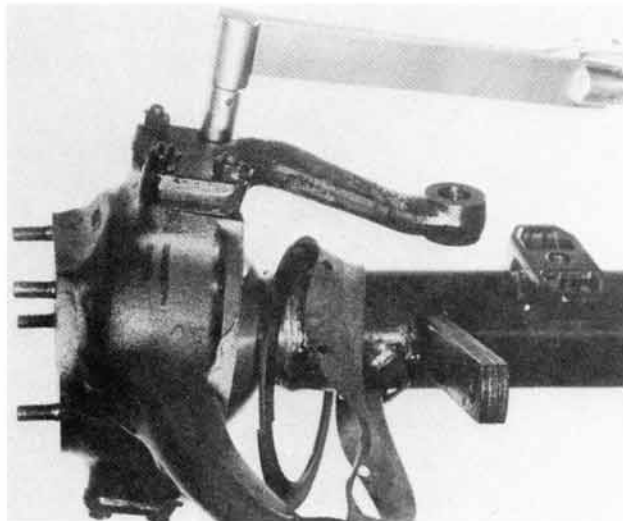
**Figure 3-16**  
Reposition knuckle in vise and assemble new key to king pin. Flat of the key is to be outboard and parallel with the pin. Line up the keyway of the new bronze bearing with the key. Tap bronze bearing with brass hammer until it is seated against the steering arm shoulder. Grease the outside of the bronze bearing with the specified grease.



**Figure 3-17**

Assemble knuckle to housing. Use new bearing cone. Hold bottom bearing cone to prevent from falling out and becoming damaged. Assemble bottom king pin bearing cap, preload shims, and cap screws.

Torque cap screws to specification.

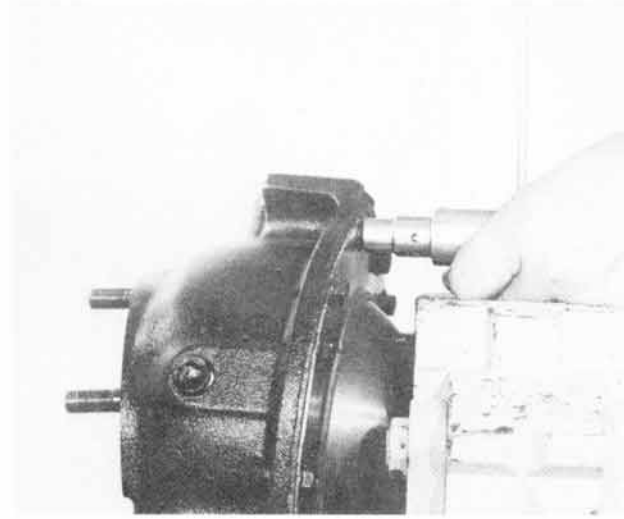


**Figure 3-18**

Place torque wrench on one screw as shown. Torque to actuate knuckle, less seal, felt, etc., is 20-30 lbs. ft. (27.1-40.7 N•m).

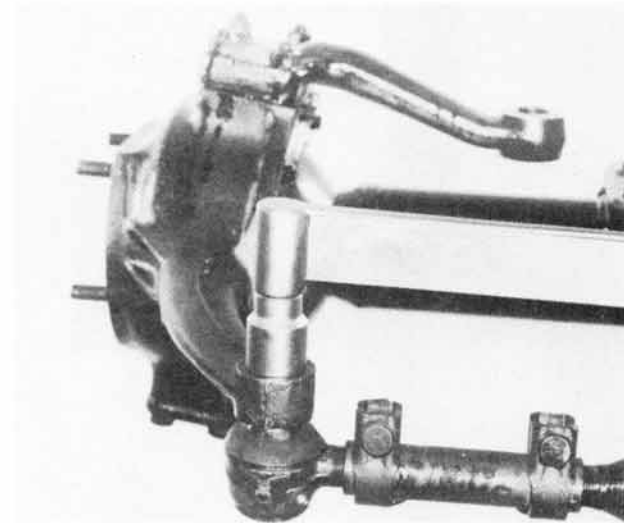
**NOTE**

If preload is too tight, correct by adding shims. If preload is too loose, correct by removing shims. Preload shim pack is located on the bottom between the bearing cap and knuckle. Shims are available in thicknesses of .003, .005, .010, and .030 in. (.08, .13, .25 and .76 mm)



**Figure 3-19**

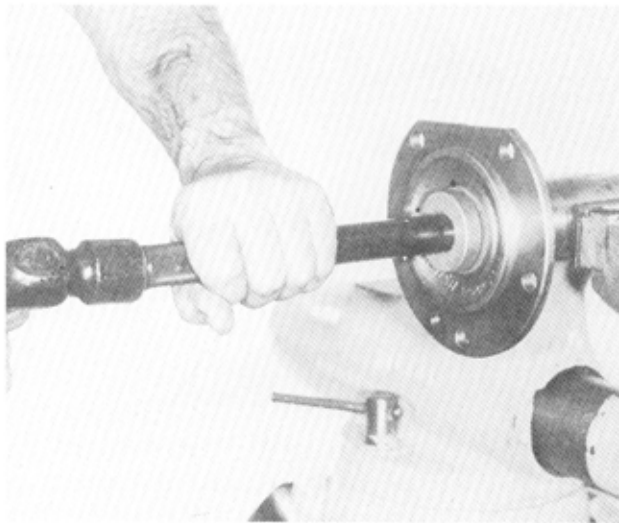
Assemble the new oil seal into knuckle. **BE SURE SPLIT OF SEAL IS TO THE TOP OF THE AXLE.** Assemble felt, two retainer plates and twelve screws. Torque screws to specification.



**Figure 3-20**

Assemble tie rod to steering arm. For specified torque on tie rod nut, refer to Vehicle Service Manual.

Assemble cotter key.



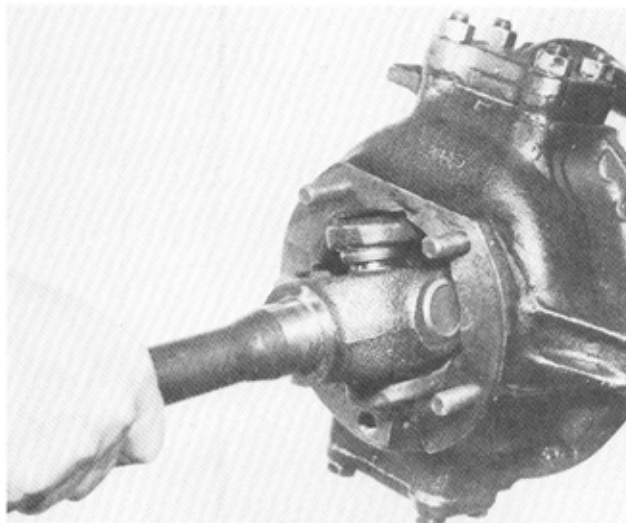
**Figure 3-21**

Position spindle in vise as shown and assemble new bushing. Grease inside of bushing with the specified grease.

TOOLS: D-161 Installer  
C-4171 Handle

**NOTE**

To set toe-in, refer to Vehicle Service Manual. Adjustments can be made by loosening clamps on the tie rod. After proper adjustment is made, retighten tie rod clamps.



**Figure 3-22**

Line up the universal joints of the axle shaft with the flat openings of the knuckle. Assemble axle shaft and joint assembly into housing.

Assemble spindle to knuckle.

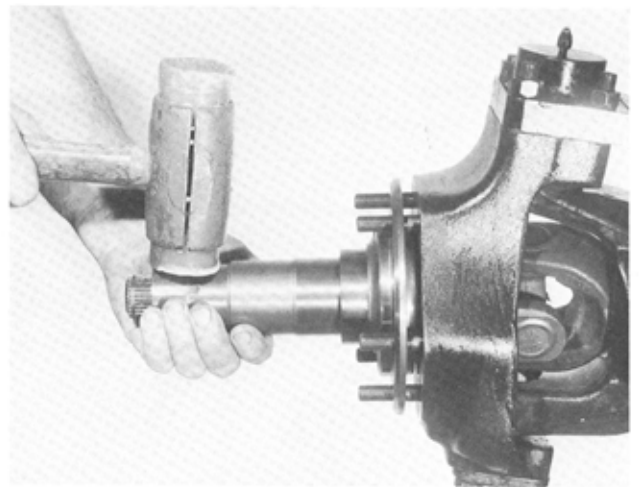
Assemble brake backing plate assembly. Refer to Vehicle Service Manual for specified screw torque.

Remove inspection plug from knuckle. Fill knuckle level to plug hole with the special lubricant. Assemble inspection plug.

**DISASSEMBLY OF WHEEL ENDS - OPEN YOKE DESIGN**

**NOTE**

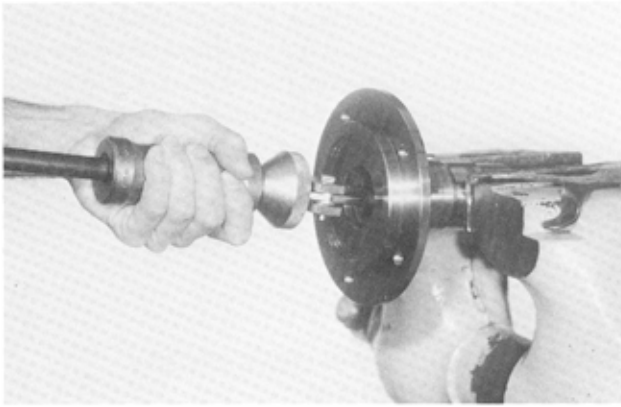
If it is necessary to replace brake components such as disc brake pads, backing plate, etc., refer to Vehicle Service Manual.



**Figure 3-23**

Remove spindle. If necessary, tap lightly with a rawhide hammer to free it from the knuckle. Check bronze spacer located between axle shaft joint assembly and bearing. If wear is evident, replace with a new one.

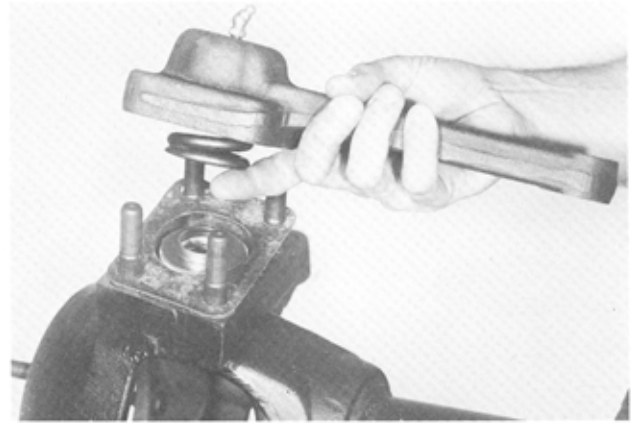




**Figure 3-24**

Place spindle in vise. Do not locate on bearing diameters. Remove needle bearing.

TOOL: D-131 Slide Hammer



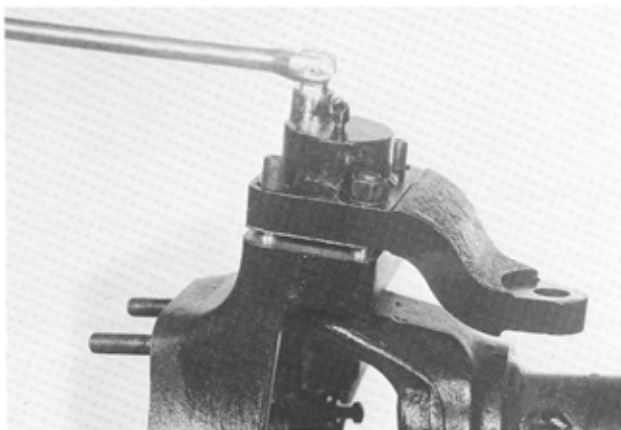
**Figure 3-26**

Remove steering arm, compression spring, and gasket. Discard gasket, replace with the new one at time of assembly.

**CAUTION**

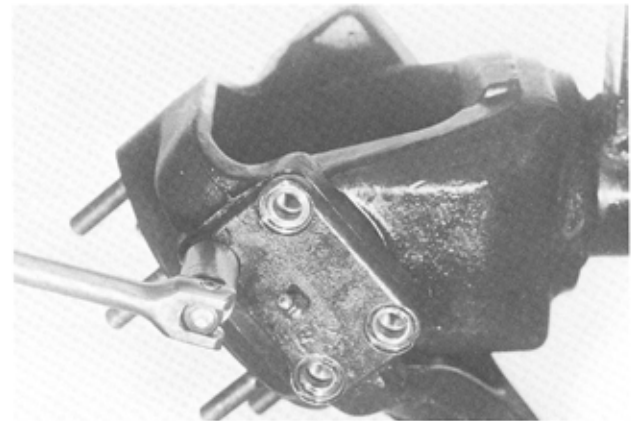
Be sure that vise jaws are equipped with brass protectors or similar type to protect the machined surfaces of any parts that are to be placed in the vise.

Remove axle shaft and joint assembly. Remove tie rod.



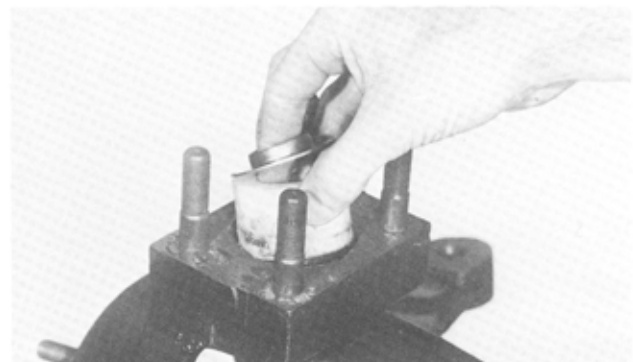
**Figure 3-25**

Remove four nuts on steering arm. Remove nuts alternately as compression spring will force steering arm up.



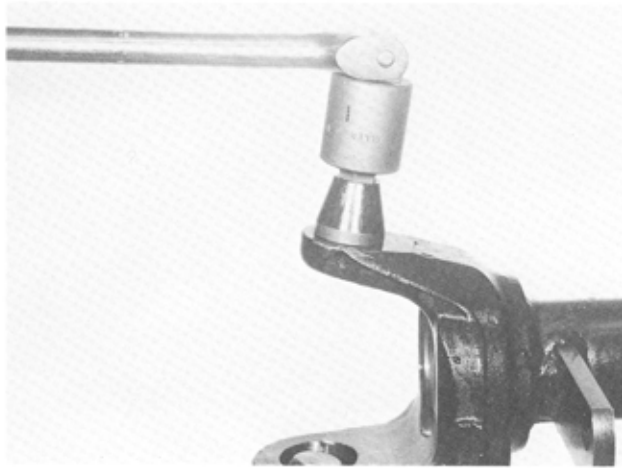
**Figure 3-27**

Remove four cap screws on bearing cap. Remove bearing cap.



**Figure 3-28**

Remove king pin tapered bushing, spring retainer, and knuckle from yoke. Remove king pin seal.



**Figure 3-29**  
Remove king pin as shown.

TOOLS: D-192 King Pin Installer and Remover



**Figure 3-30**  
Remove king pin bearing cup, cone, grease retainer, and seal all at the same time. Assemble and use tools exactly as shown. Discard seal and replace with new one at time of assembly. If grease retainer is damaged, replace with new one at time of assembly.

TOOLS: D-141 Installer  
C-4171 Handle

## ASSEMBLY



**Figure 3-31**  
Assemble new grease retainer and king pin bearing cup.

TOOLS: D-142 Installer  
C-4171 Handle



**Figure 3-32**  
Fill the area in grease retainer with specified grease, grease bearing cone and install. Install new king pin bearing oil seal.

TOOLS: D-194 Installer  
C-4171 Handle

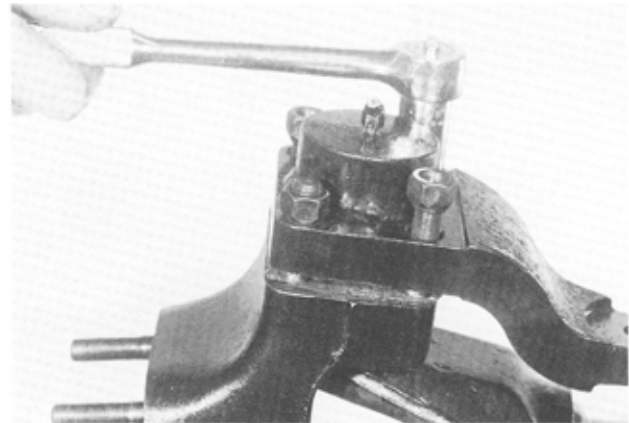




**Figure 3-33**

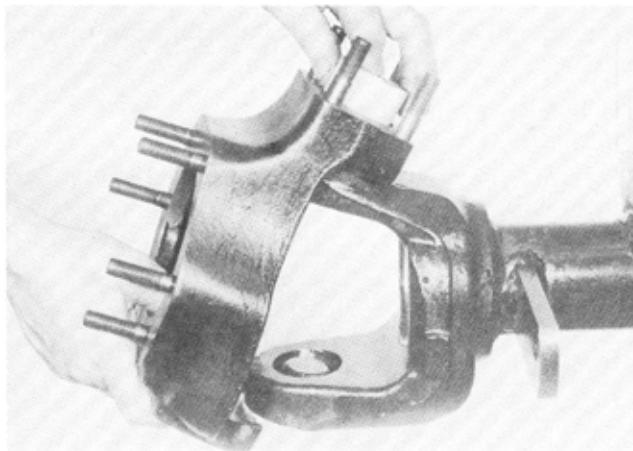
Install king pin. Torque king pin to specification.

TOOLS: D-192 King Pin Installer and Remover,  
DA-4600-FM Torque Wrench



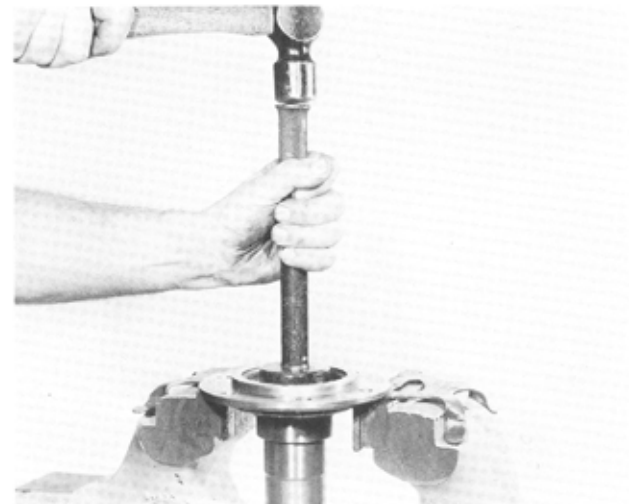
**Figure 3-36**

Assemble spring retainer and compression spring on king pin bushing. Assemble steering arm, with new gasket, over four studs. Tighten nuts alternately and evenly. Torque nuts to specification.



**Figure 3-34**

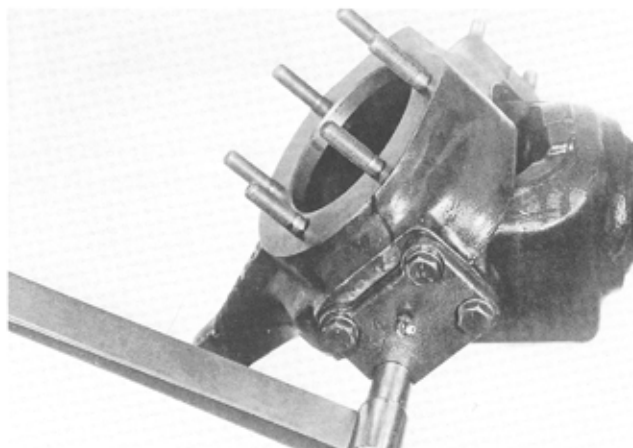
Assemble felt seal to king pin, assemble knuckle and tapered bushing over king pin.



**Figure 3-37**

Assemble new needle bearing into spindle.

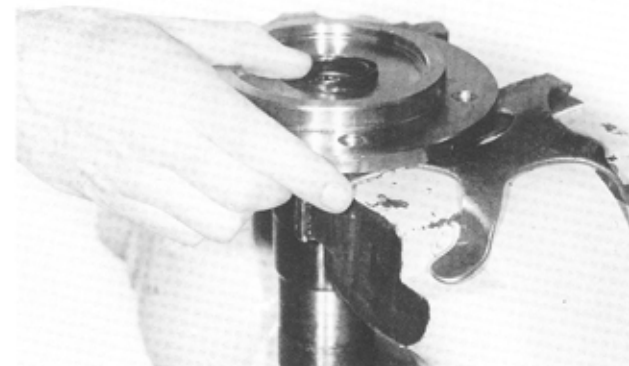
TOOLS: D-258 Installer  
C-4171 Handle



**Figure 3-35**

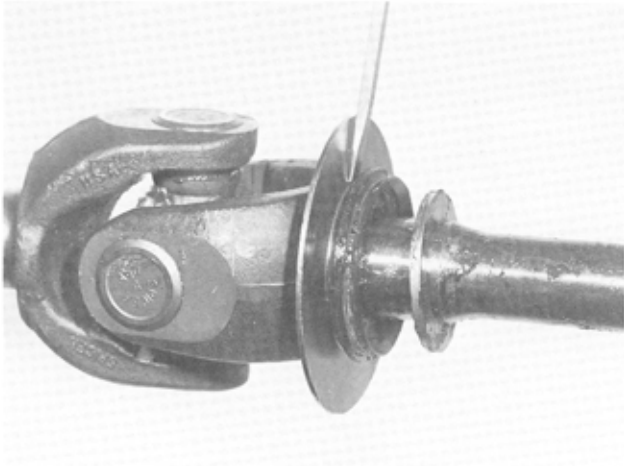
Assemble bearing cap with four cap screws. Tighten cap screws alternately and evenly. Torque cap screws to specification.

TOOL: C-524-A Torque Wrench



**Figure 3-38**

Assemble grease seal into spindle. The lip of the seal is to be directed away from the spindle.



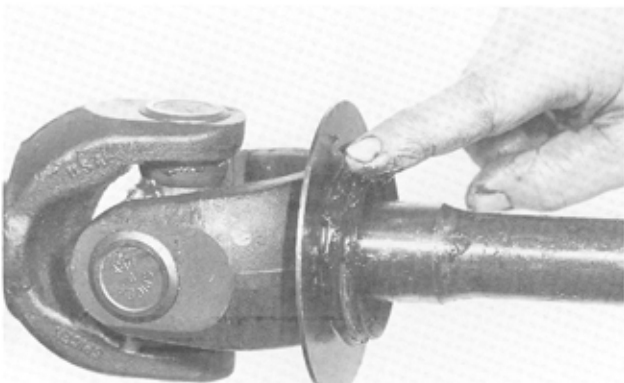
**Figure 3-39**

Some front axles are equipped with a "V" seal, which is assembled to the axle shaft stone shield as shown. If seal is worn, remove and replace with a new one.



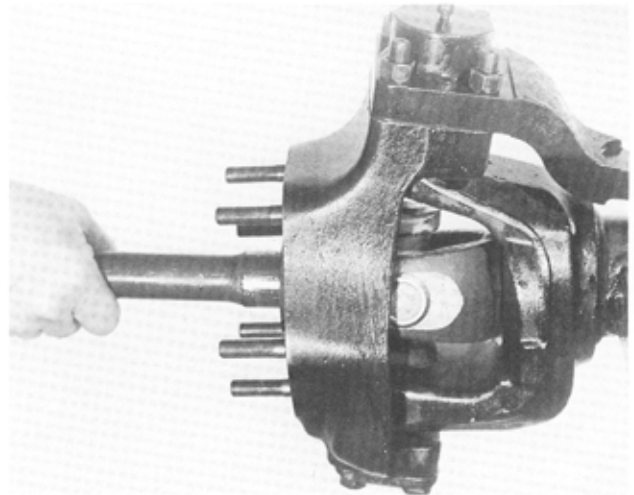
**Figure 3-40**

Assemble new seal as shown. Lip of the seal is to be directed towards the spindle.



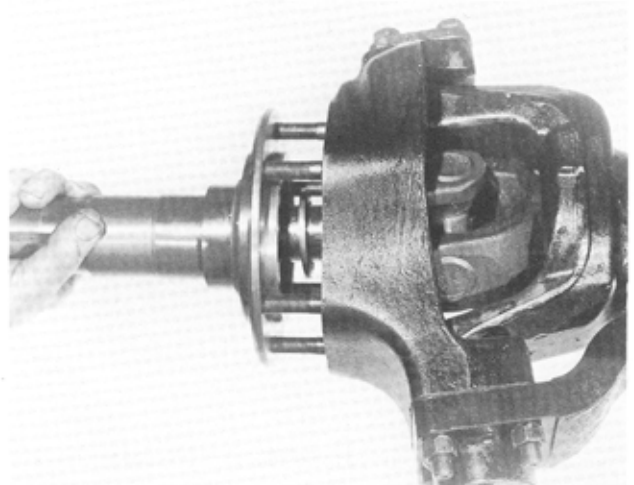
**Figure 3-41**

Pack the area around the thrust face area of the shaft and seal full of grease. Also, fill the seal area of the spindle with grease.



**Figure 3-42**

Assemble axle shaft joint assembly into housing.



**Figure 3-43**

Assemble new spacer and spindle.

**NOTE**  
Some spacers have an I.D. chamfer and should be installed with the chamfer away from the spindle.

Torque spindle nuts to specification.

## SECTION 4

# CARRIER SECTION

### DISASSEMBLY

#### NOTE

The photos or pictures contained herein are for illustrative and instructional purposes only. The appearance of your axle assembly and/or components may vary from that shown. However, the service procedures described will apply.

If it becomes necessary to disassemble any parts inside the carrier, it is suggested that the entire axle be removed from the vehicle and held tight in a stand or rack.

All dimensions are in inches unless otherwise stated. Dimensions in parentheses followed by mm are in millimeters.

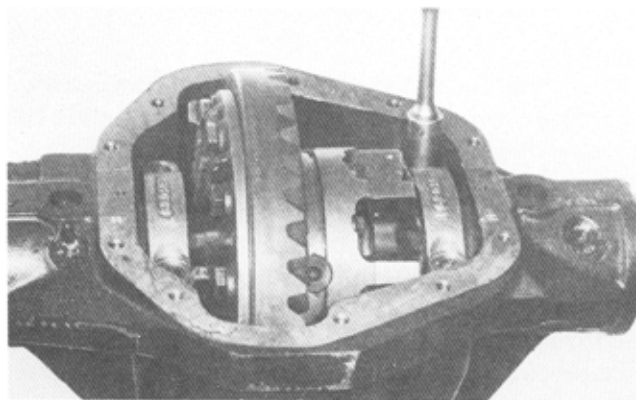


**WARNING:** When removing axle assembly, make sure vehicle is properly supported. Improperly supported vehicle can cause serious injury or death. Follow vehicle manufacturers recommendations for proper axle assembly removal procedures.

Remove cover plate from housing and drain lubricant.

#### NOTE

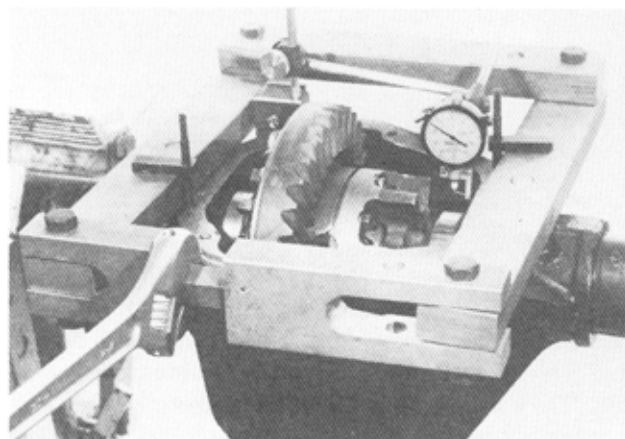
Before removing differential case assembly, make sure the axle shafts are pulled out far enough for clearance to allow removal.



**Figure 4-1**

Remove bearing caps. Note mating letters stamped on caps and carrier. This is important at time of assembly as they are to be assembled exactly as

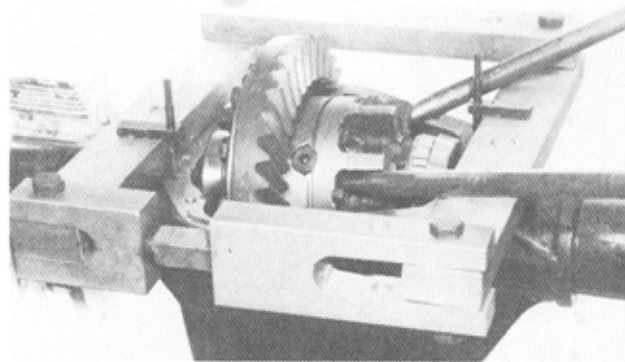
removed. Letters or numbers are in vertical and horizontal position.



**Figure 4-2**

Mount spreader to housing. **DO NOT SPREAD CARRIER OVER .015 (.38 mm).** Use dial indicator as shown.

TOOLS: D-167 Spreader  
D-128 Dial Indicator Set

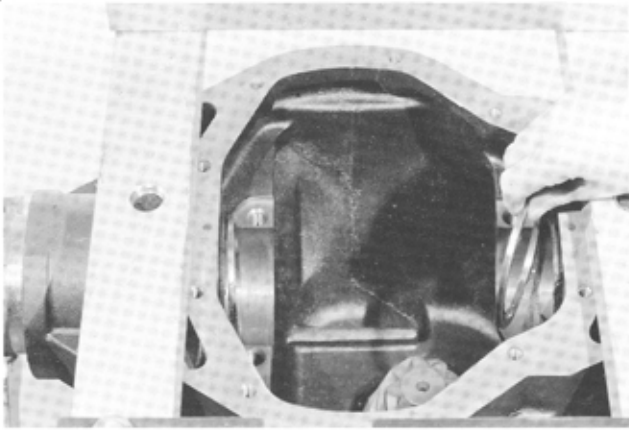


**Figure 4-3**

Pry differential case from carrier with two pry bars. After differential case has been removed, remove spreader. Use caution to avoid damage to components. Tag bearing cups indicating from which side they were removed from. See note below regarding the use of bearings.

#### NOTE

It is recommended that whenever bearings are removed, they are to be replaced with new ones, regardless of mileage.



**Figure 4-4**

Some Model 70 axles use differential bearing outboard spacers located on each side of the differential bearing bore. Remove and tag which side they were removed from. Ring gear side or opposite side. They will be reused during assembly, unless damaged or worn and need to be replaced.

**NOTE**

Check outboard spacers for damage. (e.g. bent, or deep grooves caused by worn bearings). If damaged, they should be replaced with new ones at time of assembly.



**Figure 4-5**

Remove differential bearing cones with a puller as shown. Tag cones indicating from which side they were removed from.

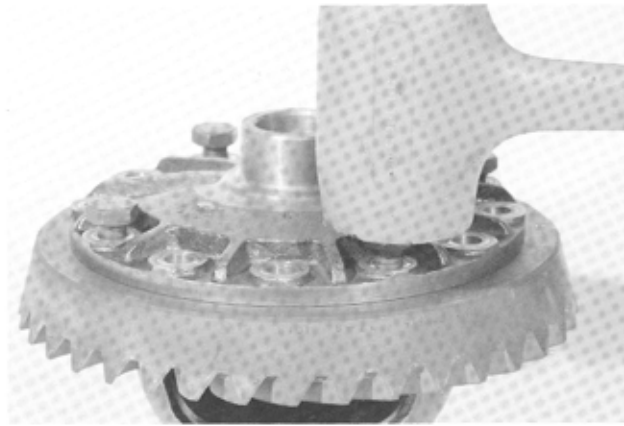
**TOOLS:** DD-914 Press

- DD-914-62 Adapters (70, 70-B, 70-U)
- DD-914-99 Adapters (70-HD, 70-3HD)
- DD-914-8 Adapter Ring
- DD-914-7 Extension
- DD-914-42 Button



**WARNING:** When pulling bearings, do not allow differential assembly to fall. It can strike legs or feet and may cause serious injury.

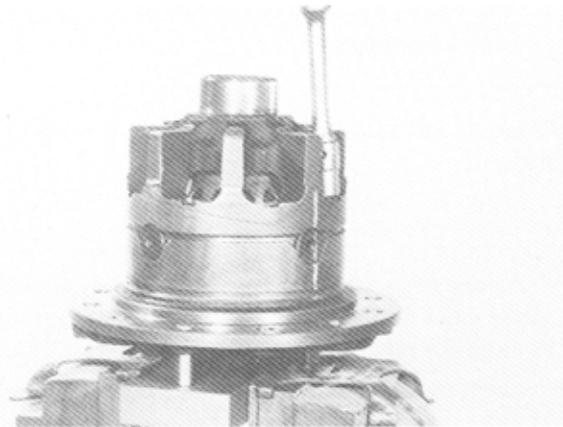
**RING GEAR REMOVAL**



**Figure 4-6**

Place differential case in vise or suitable holding fixture. Remove ring gear screws. Leave 4 screws loosely assembled 90 degrees apart. Place assembly on a solid bench. Tap screws alternately and evenly to free ring gear from differential case. Remove screws and ring gear. Discard ring gear screws. Ring gear screws are to be replaced with new ones at time of reassembly.

**SERVICING STANDARD  
DIFFERENTIAL CASE ASSEMBLY  
(TWO PIECE DESIGN)**



**Figure 4-7**

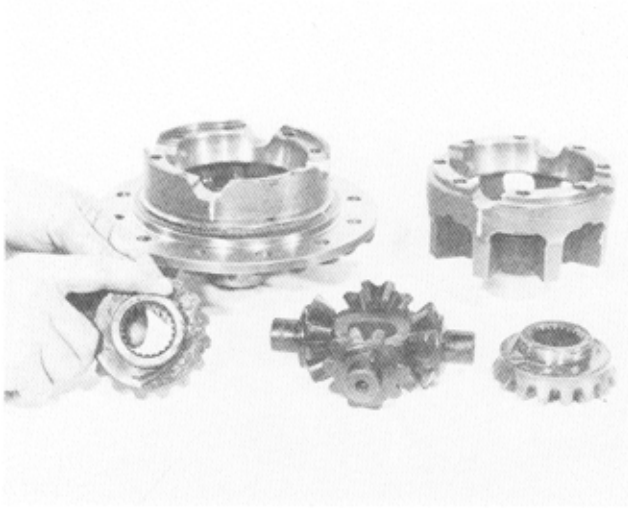
Place holding fixture into vise. Place case onto holding fixture. Scribe a mark on both case halves to indicate their proper position at time of assembly. Remove case body bolts.

Tap lightly on top half of case with rawhide hammer to free it from bottom half. Remove top half of case. Lift out all internal parts of the case, such as side gears, pinion mate gears, cross pin, spherical and thrust washers.

Inspect all parts, including the machined surfaces of the case itself. Where necessary, replace all worn parts. If excessive wear is noticed on all parts, it is suggested that the complete differential assembly be replaced.

If any gears are to be replaced, they are to be replaced in sets.

Tool: D-166 Holding Fixture



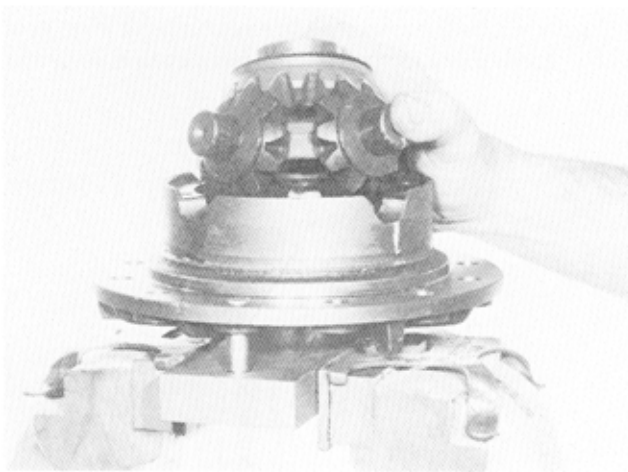
**Figure 4-8**

Assemble washers to side gears. Apply a small amount of grease on the side gear hubs.

Assemble pinion mate gears and washers on cross shaft.

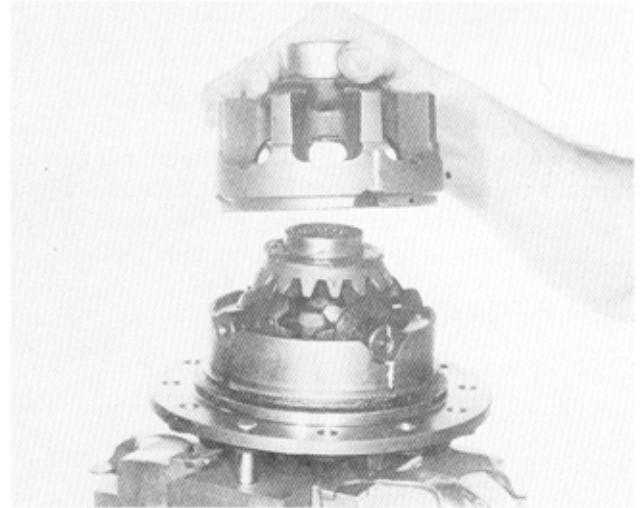
**NOTE**

Always replace gears as a complete set. Do not mix new gears with old gears, as this may cause uneven wear and short gear life.



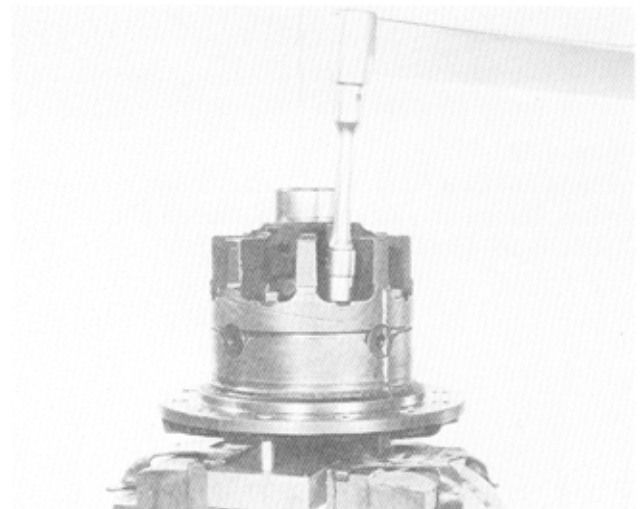
**Figure 4-9**

Position flange half of case on holding fixture. Assemble side gears, pinion mate gears, cross shaft, and washers into flange half of case.



**Figure 4-10**

Assemble top half (button) of case, **MAKING SURE SCRIBE MARKS ARE LINED UP**. Assemble body bolts finger tight only.



**Figure 4-11**

Tighten body bolts evenly. Torque body bolts to specification.

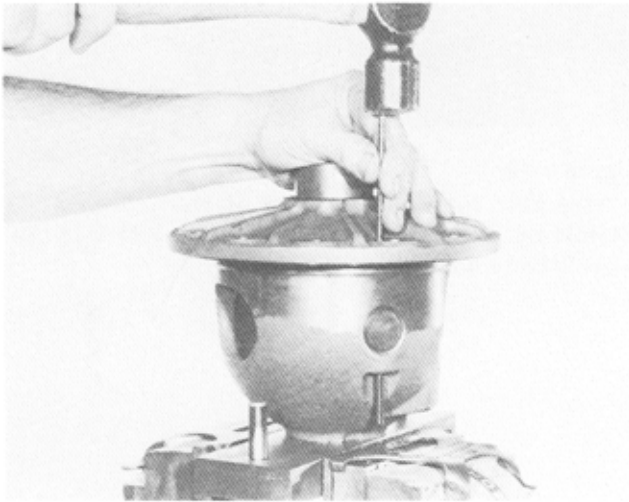
Remove case and holding fixture from vise.



## SERVICING STANDARD DIFFERENTIAL CASE ASSEMBLY (ONE PIECE DESIGN)

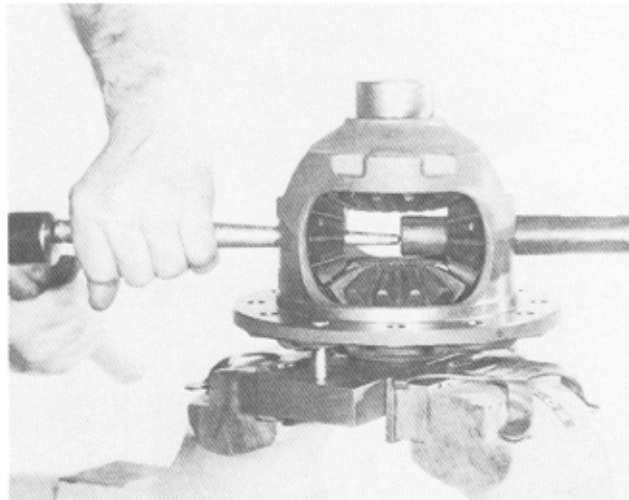
The differential assembly may be serviced at this time, if required. If differential case, side gears and pinion mate gears are useable and do not require servicing, proceed to DRIVE PINION REMOVAL.

### CASE DISASSEMBLY



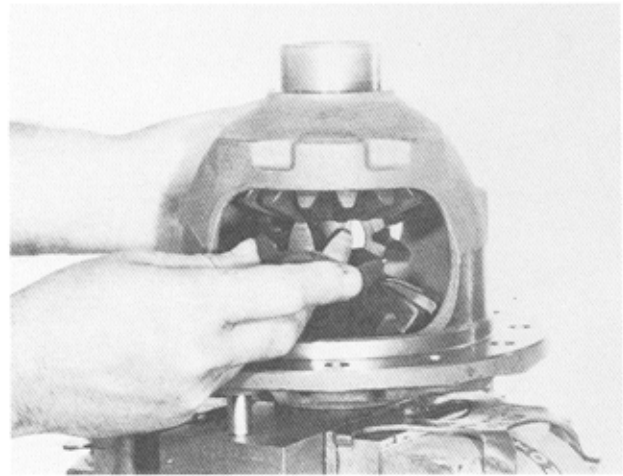
**Figure 4-12**

Place holding fixture into vise. Place case onto holding fixture as shown. Drive out roll pin.  
TOOL: D-166 Holding Fixture.



**Figure 4-13**

Remove differential pinion mate shaft with drift.



**Figure 4-14**

Rotate gears until the pinion mate (small gears) enter the large opening of the case. Remove pinion mate gears and spherical washers. After removal of the pinion mate gears, the side gear and thrust washers can be easily removed.

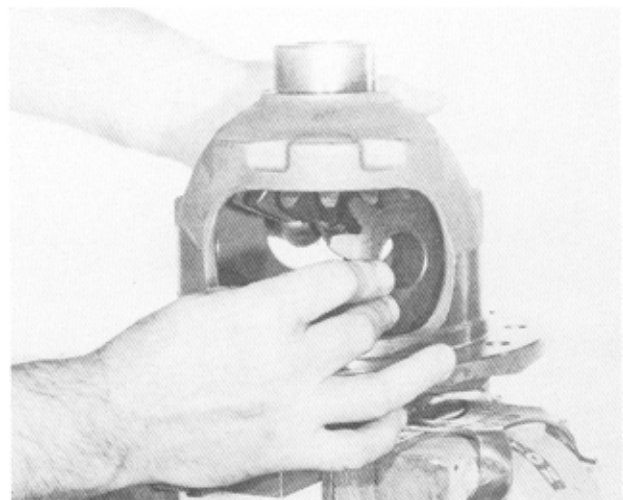
Inspect and replace components as required.

#### NOTE

Always replace gears as a complete set. Do not mix new gears with old gears, as this may cause uneven wear and short gear life.

### CASE REASSEMBLY

Apply a small amount of grease on both side gear hubs. Assemble new thrust washers onto side gears.

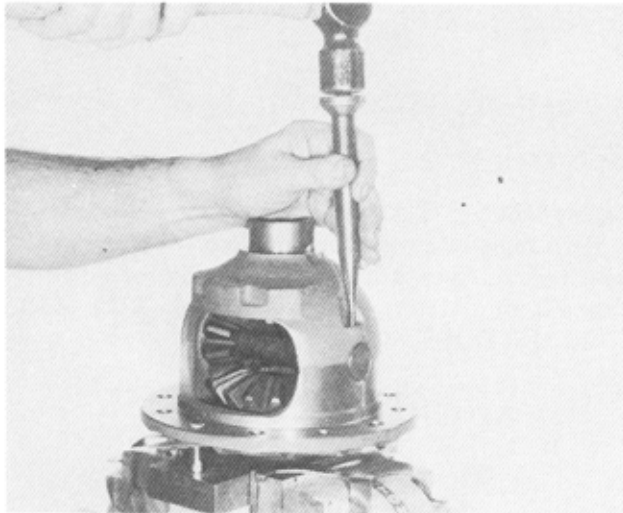


**Figure 4-15**

Assemble both side gears into case. Hold top side gear up with fingers. Assemble one pinion mate gear. Rotate gears until pinion mate gear is directly in the center of the small opening of the case. Line up the

other pinion mate gear with the gear which has just been assembled. Rotate gears until the holes of pinion mate gears are in direct line with the pinion mate shaft holes of the differential case.

After making sure the gears are in alignment, apply a small amount of grease to the new spherical washers. Assemble washers between the gears and case. Also line up the holes of the washers with those of the gears and case. Assemble pinion mate cross shaft, make sure lock pin hole of the shaft is in vertical position and lined up with the lock pin hole of the case.



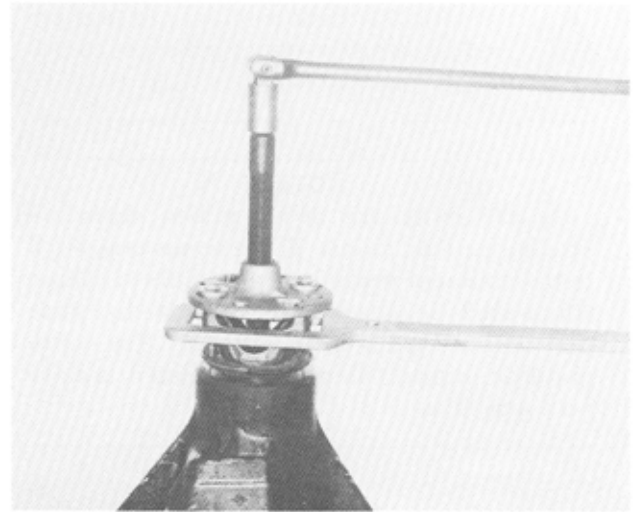
**Figure 4-16**

Assemble new roll pin. Peen metal of case over pin to lock in place.

### DRIVE PINION REMOVAL

Secure end yoke or flange with holding wrench, and remove pinion nut and washer. NOTE: PINION NUT HAS 300 LBS. FT. (406.8 N•m) MAX. OF TORQUE FOR RETENTION.

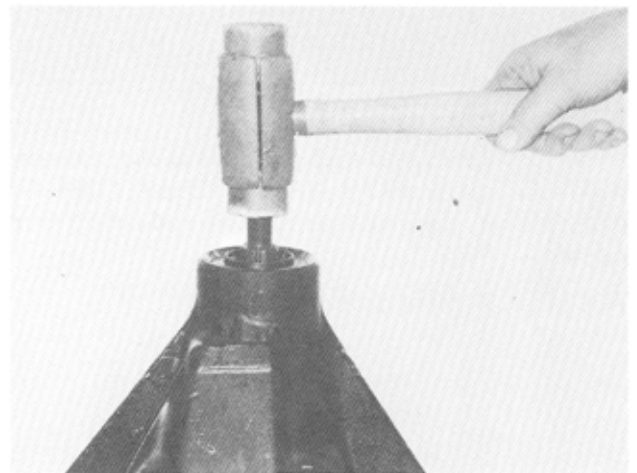
TOOL: C-3281 Holding Wrench



**Figure 4-17**

Remove end yoke or flange with tools as shown. If yoke or flange shows wear in the area of the seal contact, it should be replaced.

TOOLS: C-452 Yoke Remover  
C-3281 Holding Wrench



**Figure 4-18**

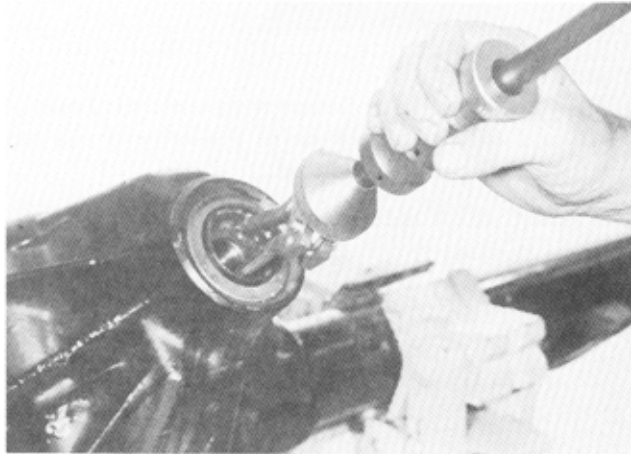
Remove pinion by tapping with a rawhide or plastic hammer. Catch the pinion with your hand to prevent it from falling and being damaged.



**WARNING:** Gear teeth may have sharp edges. When handling gears, use care to avoid personal injury.

**NOTE**

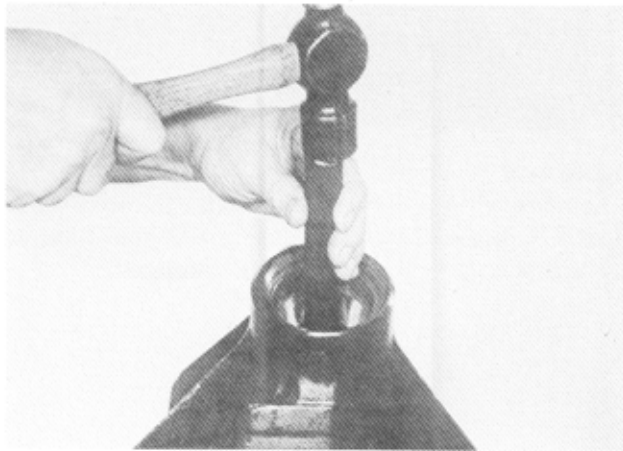
On the spline end of the pinion, there are bearing preload shims. These shims may stick to the pinion or bearing or even fall out. These shims are to be collected and kept together since they will be used later in assembly. Try not to mutilate shims. If shims are mutilated, replace with new ones.



**Figure 4-19**

Pull out pinion seal with puller as shown. Discard seal. **REPLACE WITH NEW ONE AT TIME OF ASSEMBLY.** Remove bearing cone and outer thrust washer.

TOOL: D-131 Slide Hammer.



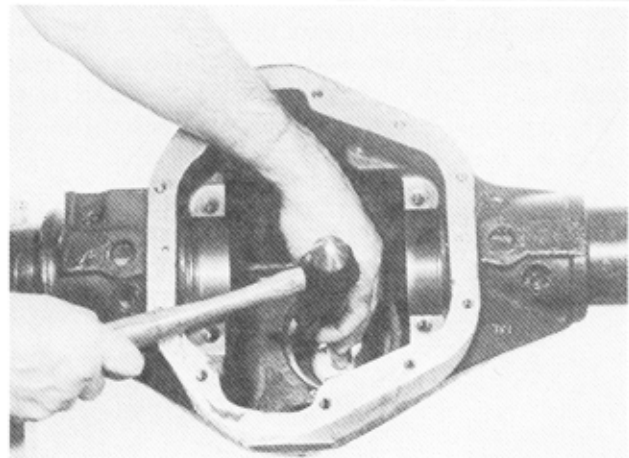
**Figure 4-20**

Remove the inner bearing cup with tools as shown.

TOOLS: D-159 Cup Remover  
(70, 70-B, 70-HD, 70-3HD)  
D-162 Cup Remover (70-U)  
C-4171 Universal Handle

**NOTE**

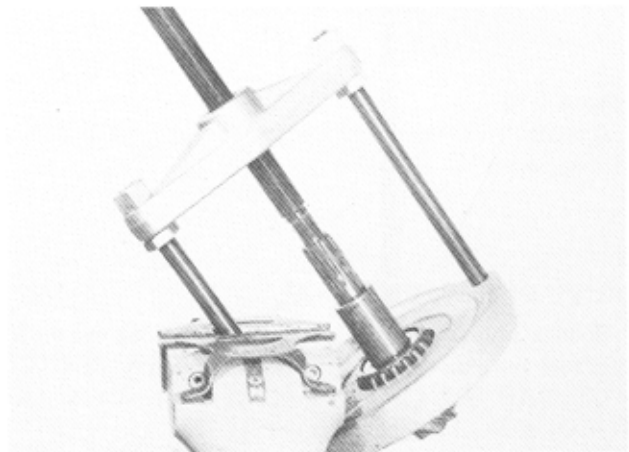
Shims are located between the bearing cup and carrier bore and may also include an oil baffle, depending upon the application. If shims and baffle are bent or nicked, they should be replaced at time of assembly.



**Figure 4-21**

Turn nose of carrier down. Remove outer pinion bearing cup. Locate driver on back edge of cup; drive cup out of carrier. **CAUTION: DO NOT NICK CARRIER BORE.**

TOOLS: D-158 Cup Remover  
C-4171 Handle



**Figure 4-22**

Remove pinion bearing with tools as shown.

TOOLS: DD-914-P Press  
DD-914-8 Adapter Ring  
DD-914-95 Adapters  
(70, 70-B, 70-HD, 70-3HD)  
C-293-37 Adapters (70-U)



**WARNING:** Do not allow gear to fall. It can strike legs or feet and may cause serious injury. Gear teeth may have sharp edges. When handling, use care to avoid cutting hands.



## RING & PINION GEAR ASSEMBLY THEORY



**Figure 4-23 (View of ring & pinion set)**

Ring gears and pinions are supplied in matched sets only. Matching numbers on both the pinion and ring gear are etched for verification. If a new gear set is being used, verify the numbers of each pinion and ring gear before proceeding with assembly.

The nominal distance from the centerline of the ring gear to the button end of the pinion for the Model 70 axle is 3.500 in. (88.9 mm).

On the button end of each pinion, there is etched a plus (+) number, a minus (-) number, or a zero (0) which indicates the best running position for each particular gear set. This dimension is controlled by the shimming behind the inner pinion bearing cup.

For example: If a pinion is etched plus +3 (m+8), this pinion would require .003 in. (.08 mm) less shims than a pinion etched "0". This means by removing shims, the mounting distance of the pinion is increased to 3.503 in. (88.98 mm), which is just what a +3 (m+8) indicates. Or if a pinion is etched -3 (m-8), we would want to add .003" (.08 mm) more shims than would be required if the pinion were etched "0". By adding .003 in. (.08 mm) shims, the mounting distance of the pinion was decreased to 3.497 inches (88.82 mm) which is just what a -3 (m-8) indicates.

If the old ring and pinion set is to be reused, measure the old shim pack and build a new shim pack to this same dimension. If a baffle is used in the axle assembly, it is considered as part of the shim pack.

To change the pinion adjustments, use different combination of the pinion shims which come in different thicknesses.

### NOTE

If baffle or slinger is bent or mutilated, it should be replaced.

Measure each shim separately with a micrometer and add together to get total shim pack thickness from the original build-up.

If a new gear set is being used, notice the (+) or (-) etching on both the old and new pinion and adjust the thickness of the new shim pack to compensate for the differences of these two figures.

For example: If the old pinion reads +2 (m+5) and the new pinion is -2 (m-5), add .004" (.10 mm) shims to the original shim pack.

| Old Pinion Marking | New Pinion Marking |        |        |        |        |        |        |        |        |
|--------------------|--------------------|--------|--------|--------|--------|--------|--------|--------|--------|
|                    | -4                 | -3     | -2     | -1     | 0      | +1     | +2     | +3     | +4     |
| +4                 | +0.008             | +0.007 | +0.006 | +0.005 | +0.004 | +0.003 | +0.002 | +0.001 | 0      |
| +3                 | +0.007             | +0.006 | +0.005 | +0.004 | +0.003 | +0.002 | +0.001 | 0      | -0.001 |
| +2                 | +0.006             | +0.005 | +0.004 | +0.003 | +0.002 | +0.001 | 0      | -0.001 | -0.002 |
| +1                 | +0.005             | +0.004 | +0.003 | +0.002 | +0.001 | 0      | -0.001 | -0.002 | -0.003 |
| 0                  | +0.004             | +0.003 | +0.002 | +0.001 | 0      | -0.001 | -0.002 | -0.003 | -0.004 |
| -1                 | +0.003             | +0.002 | +0.001 | 0      | -0.001 | -0.002 | -0.003 | -0.004 | -0.005 |
| -2                 | +0.002             | +0.001 | 0      | -0.001 | -0.002 | -0.003 | -0.004 | -0.005 | -0.006 |
| -3                 | +0.001             | 0      | -0.001 | -0.002 | -0.003 | -0.004 | -0.005 | -0.006 | -0.007 |
| -4                 | 0                  | -0.001 | -0.002 | -0.003 | -0.004 | -0.005 | -0.006 | -0.007 | -0.008 |

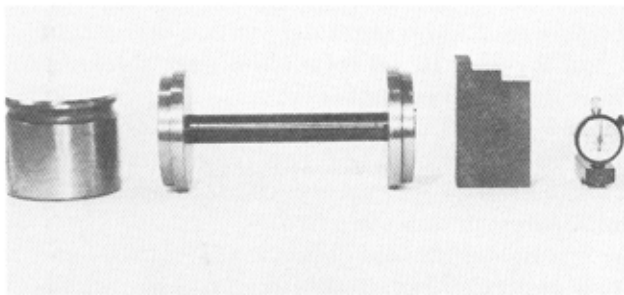
**Figure 4-24 (Pinion Setting Chart - English U.S. Standard)**

| Old Pinion Marking | New Pinion Marking |       |       |       |       |       |       |       |       |
|--------------------|--------------------|-------|-------|-------|-------|-------|-------|-------|-------|
|                    | -10                | -8    | -5    | -3    | 0     | +3    | +5    | +8    | +10   |
| +10                | +0.20              | +0.18 | +0.15 | +0.13 | +0.10 | +0.08 | +0.05 | +0.03 | 0     |
| +8                 | +0.18              | +0.15 | +0.13 | +0.10 | +0.08 | +0.05 | +0.03 | 0     | -0.03 |
| +5                 | +0.15              | +0.13 | +0.10 | +0.08 | +0.05 | +0.03 | 0     | -0.03 | -0.05 |
| +3                 | +0.13              | +0.10 | +0.08 | +0.05 | +0.03 | 0     | -0.03 | -0.05 | -0.08 |
| 0                  | +0.10              | +0.08 | +0.05 | +0.03 | 0     | -0.03 | -0.05 | -0.08 | -0.10 |
| -3                 | +0.08              | +0.05 | +0.03 | 0     | -0.03 | -0.05 | -0.08 | -0.10 | -0.13 |
| -5                 | +0.05              | +0.03 | 0     | -0.03 | -0.05 | -0.08 | -0.10 | -0.13 | -0.15 |
| -8                 | +0.03              | 0     | -0.03 | -0.05 | -0.08 | -0.10 | -0.13 | -0.15 | -0.18 |
| -10                | 0                  | -0.03 | -0.05 | -0.08 | -0.10 | -0.13 | -0.15 | -0.18 | -0.20 |

**Figure 4-25 (Pinion Setting Chart - Metric)**

If metric, pinion will be etched (m+ some number). Example (m+5). Use these charts as a guideline to set pinion.

**ESTABLISHING PINION GEAR DEPTH USING SPECIAL SERVICE TOOLS.**

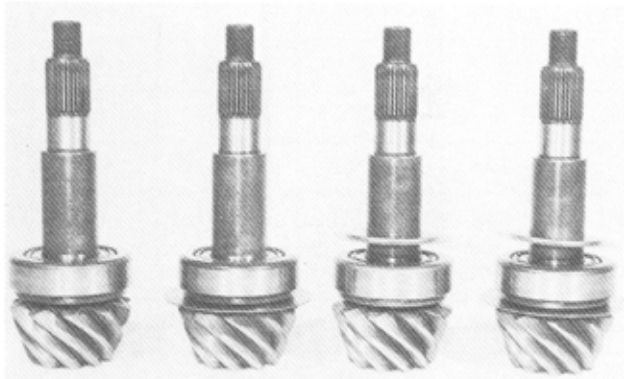


**Figure 4-26**

View of master pinion block, cross arbor, arbor discs, pinion height block, and scooter gage.

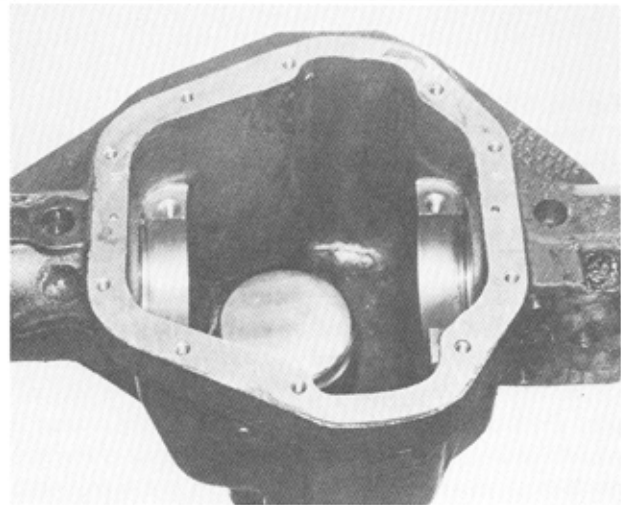
**NOTE**

Make sure that all carrier bores are free from all nicks, dirt or any other contamination.



**Figure 4-27**

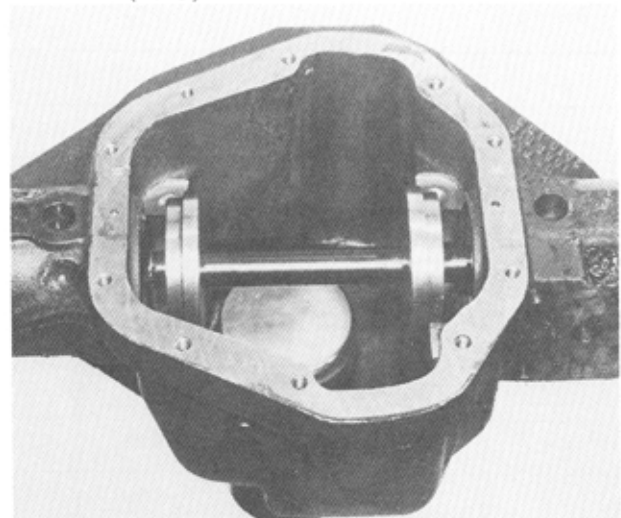
The baffles serve the purpose of assisting lube flow through the oil channels to lubricate the pinion bearings. If used, they are part of the pinion setting adjustment. In Figure 4-27 we show the four different options.



**Figure 4-28**

Place the master pinion block into the pinion bore of the carrier as shown.

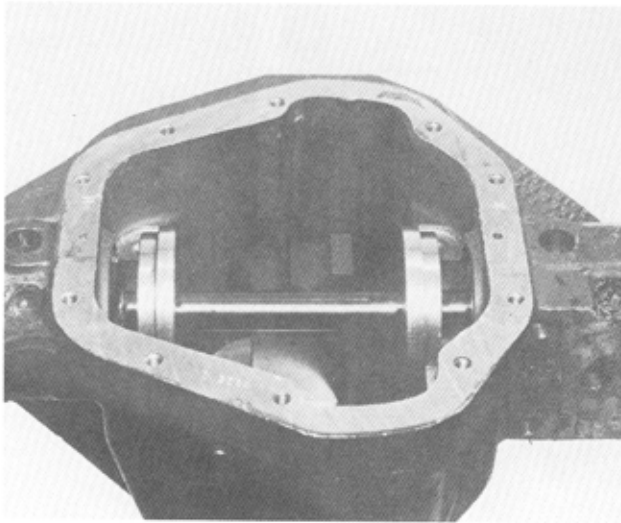
TOOLS: D-137 Master Pinion Block (70, 70-B, 70-HD, 70-3HD)  
D-120 Master Pinion Block (70-U)



**Figure 4-29**

Place arbor discs and arbor into cross bores of the carrier as shown.

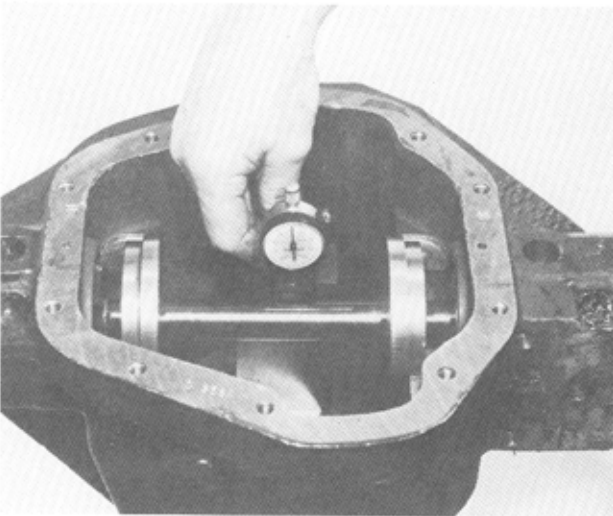
TOOLS: D-115-3 Arbor  
D-116-2-70 Arbor Discs (70, 70-B, 70-U)  
D-116-2-70HD Arbor Discs (70-HD, 70-3HD)



**Figure 4-30**

Place pinion height block on top of master block and against arbor as shown.

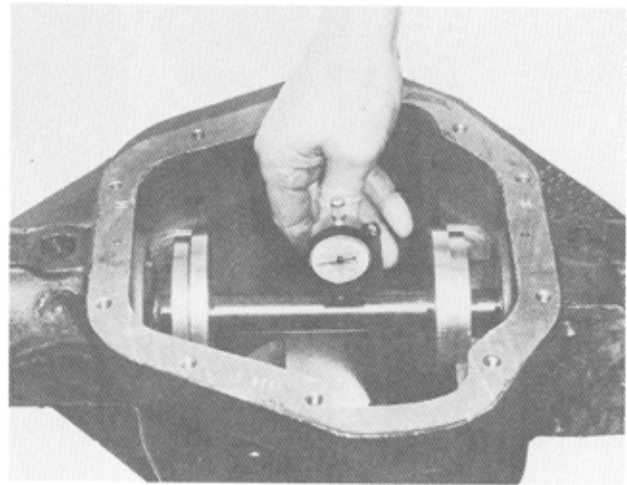
TOOL: D-116-1 Pinion Height Block



**Figure 4-31**

Place scooter gage on small step of pinion height block. Apply pressure with fingers making sure the gage is flat on the pinion height block; while pressure is applied, set indicator at zero "0".

TOOL: D-115-2 Scooter Gage

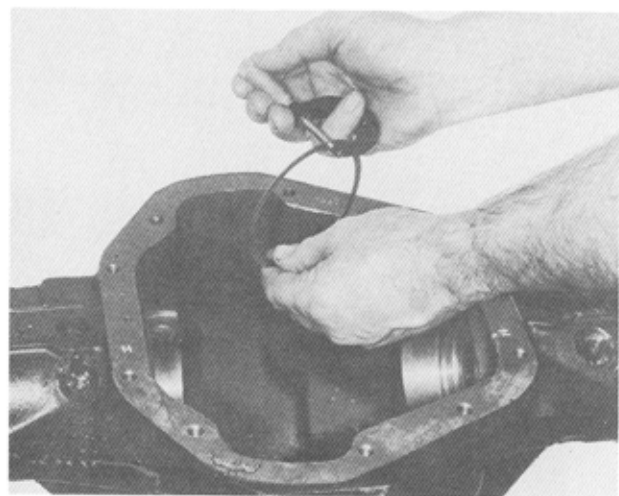


**Figure 4-32**

Slide scooter gage over arbor. As gage slides over top of arbor, it will travel in a clockwise direction. When indicator is on center of arbor (on top), it will stop traveling in a clockwise direction. If indicator starts to travel in a counterclockwise direction, this means that you have passed the center (top) of the arbor. Record only the reading when the indicator is at the highest point. This reading indicates the amount of shims necessary to obtain the correct shim pack, plus or minus the etching on the button end of the pinion. If the etching is zero (0), the shim pack will remain unchanged.

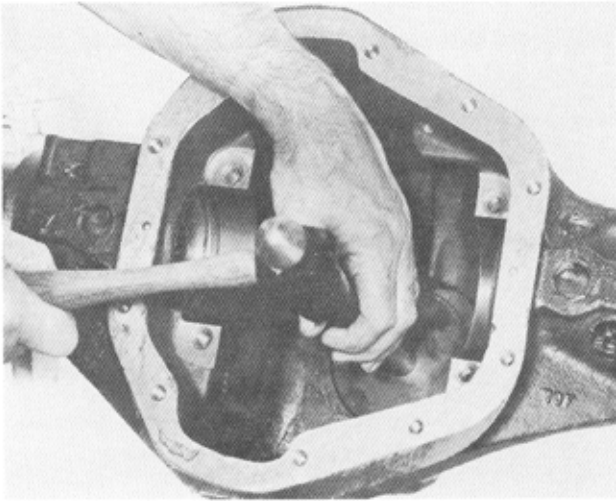
For example: If a pinion is etched +3, (m+8), this pinion would require .003" (.08 mm) less shims than a pinion etched zero "0".

If a pinion is etched -3 (m-8), we would want to add .003" (.08 mm) shims than would be required if the pinion were etched zero "0".



**Figure 4-33**

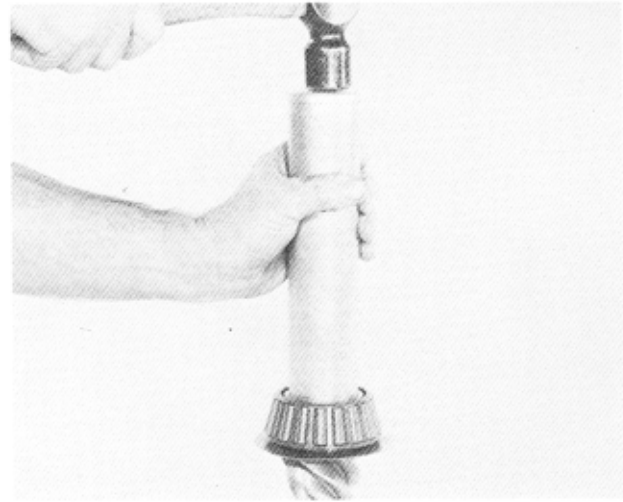
Measure each shim separately with a micrometer and add together to get total shim pack thickness. If baffle is required, it is to be included in the shim pack. If slinger is used between the inner bearing cone and thrust face of pinion, the slinger is also to be measured and included as a part of the total shim pack.



**Figure 4-34**

Place the required amount of shims (and baffle if used) in the inner bearing bore; drive the inner bearing cup into carrier with tools as shown.

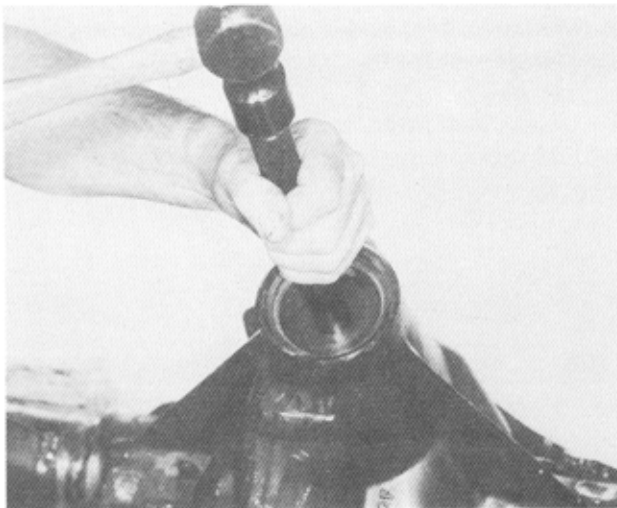
TOOLS: C-4204 Cup Installer  
(70, 70-B, 70-HD, 70-3HD)  
D-111 Cup Installer (70-U)  
C-4171 Handle



**Figure 4-36**

Assemble inner bearing cone (and a slinger if used) on pinion; place bearing installer over pinion shaft as shown. Drive bearing on shaft until it is completely seated.

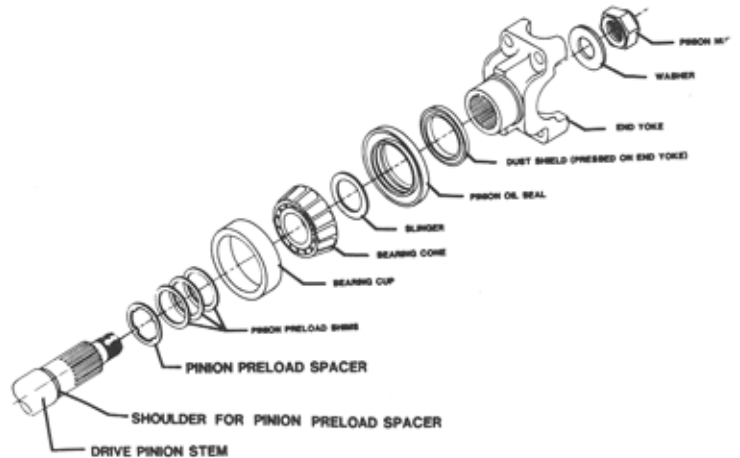
TOOLS: C-3095-A Installer  
C-4171 Handle



**Figure 4-35**

Assemble the outer pinion bearing cup into carrier as shown.

TOOLS: C-4203 Cup Installer  
C-4171 Handle



**Figure 4-37**

Figure 4-37 shows the assembly sequence for the drive pinion preload spacer that is included in service kits and current design assemblies

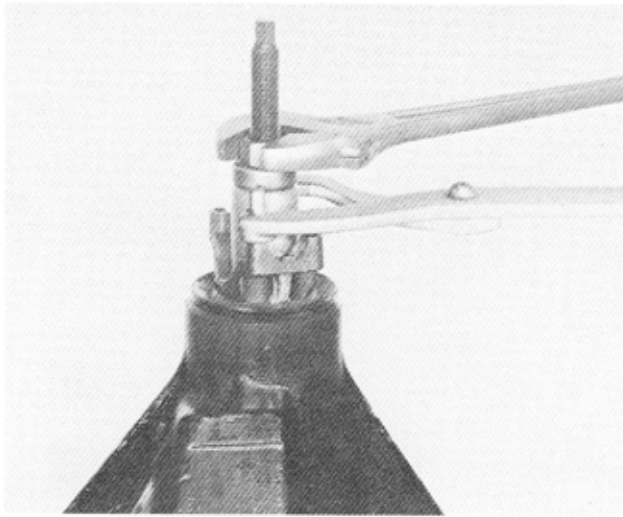


**WARNING: Gear teeth may have sharp edges. When handling gears, use care to avoid personal injury.**

### CAUTION

The drive pinion preload spacer and preload shims assembly sequence must be followed. If sequence is not followed and components are improperly assembled, it may cause unit failure.

Axle assemblies manufactured without and prior to the use of the pinion preload spacer may be serviced with this drive pinion and preload spacer.



**Figure 4-38**

Install pinion into carrier.

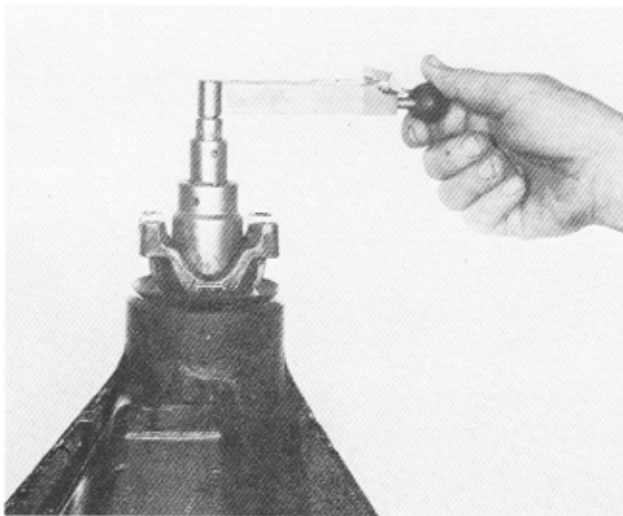
Assemble outer pinion bearing cone, (slinger if used) and end yoke onto pinion spline.

**NOTE**

Do not assemble preload shims or pinion oil seal at this time.

Use yoke installer (as shown) to assemble end yoke onto spline of pinion

TOOLS: C-3718 Installer  
C-3281 Holder



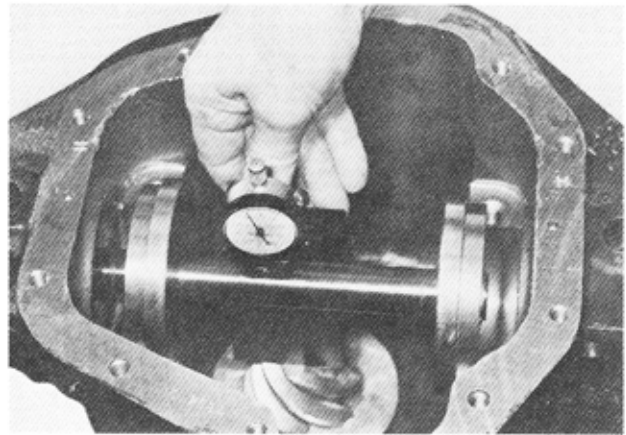
**Figure 4-39**

Assemble washer and pinion nut. Torque nut until it requires 10 lbs. in. (1.13 N•m) to rotate pinion. Rotate pinion several times before checking pinion position. This is to seat the bearings and assure a more accurate reading of pinion depth setting.

TOOL: C-4809 Torque Wrench

**NOTE**

The reason for not assembling preload shims and new pinion oil seal at this time is due to the possibility of having to adjust pinion preload or pinion adjustment. It would be necessary to again remove the seal, and as mentioned, whenever seals are removed, they are to be discarded because of possible damage.



**Figure 4-40**

Place arbor and discs (small diameter end for 70, 70-B and 70-U; large diameter for 70-HD and 70-3HD) into cross bore of carrier. Place pinion height block on button end of pinion. Set dial indicator on height block (high step of block). Set dial indicator at zero (0). Slide scooter gage across or over arbor.

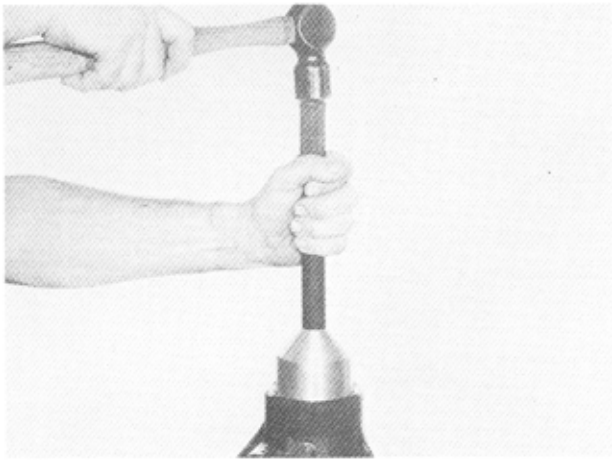
Indicator will read a plus (+) or minus (-) at its highest point, depending on the etching of the pinion.

**NOTE**

Indicator reading within .002 in. (.05 mm) of etching is considered acceptable. If pinion position is found to be within specification, continue with build-up. If pinion position is not within specification, change shim pack thickness under inner bearing cup.

Remove pinion nut, washer, end yoke, and pinion. Assemble preload shims onto pinion. NOTE: If old shims are available, measure shim pack and build up new shim pack using new shims of the same thickness. If old shim pack is not available for reference, build shim pack up to .060 in. (1.52 mm) thick. This will provide a starting point and may require adjustment.

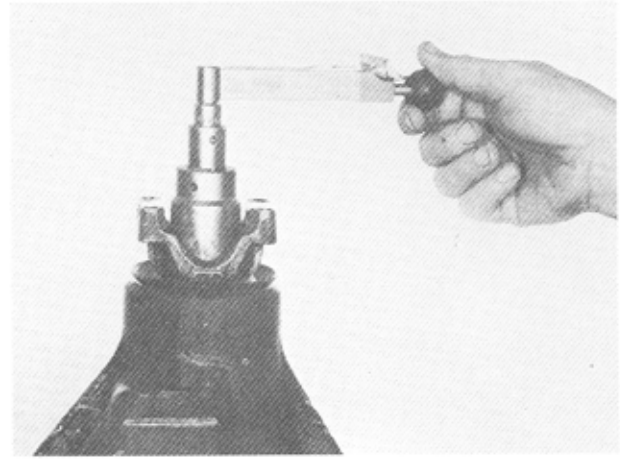




**Figure 4-41**

Apply a light coat of hypoid lubricant on the lip of pinion seal and assemble into carrier.

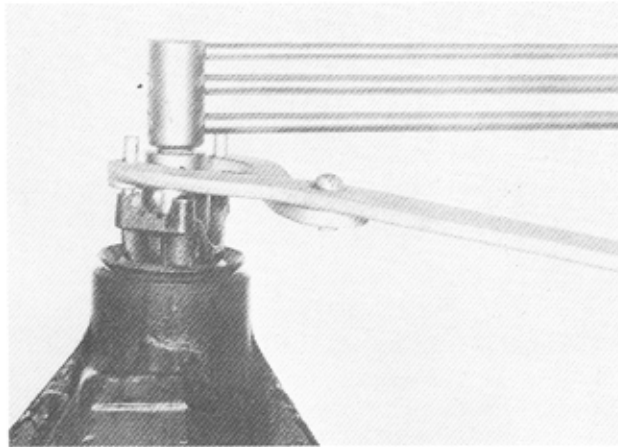
TOOLS: D-163 Pinion Seal Installer (National)  
 D-164 Pinion Seal Installer  
 (Chicago Rawhide)  
 C-4171 Universal Handle



**Figure 4-43**

Use an inch pound torque wrench to measure pinion bearing preload (also called pinion torque to rotate). Rotate the pinion several revolutions to seat the bearings and measure pinion torque to rotate (with new bearings).

If necessary adjust the preload to get within specification. To increase pinion torque to rotate, reduce the pinion preload shim stack thickness. To decrease pinion torque to rotate, increase the pinion preload shim stack thickness.



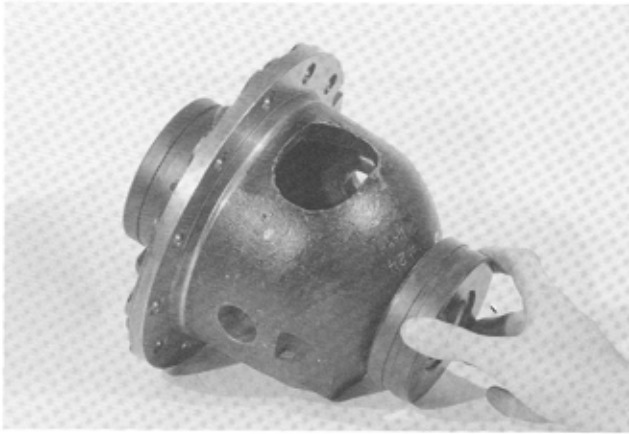
**Figure 4-42**

Assemble pinion, end yoke, washer, and **new pinion nut**. Torque nut to specification.

TOOLS: C-3281 End Yoke Holder  
 DA-4600-FM Torque Wrench

NOTE: Torque wrench must be capable of 300 lbs. ft. (406.8 N•m) torque.

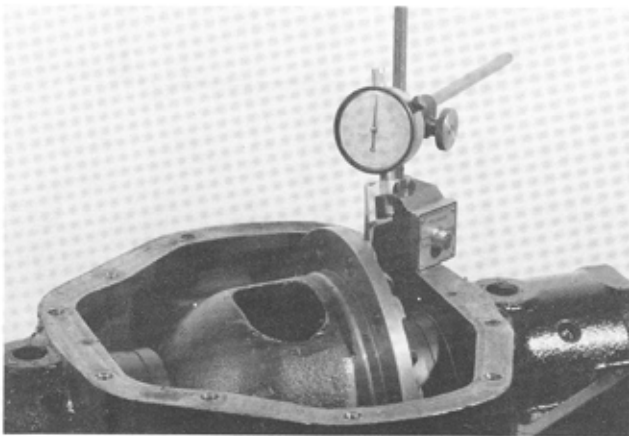
## ASSEMBLY OF DIFFERENTIAL



**Figure 4-44**

Assemble master differential bearings onto case with I.D. chamber towards case. Remove all nicks, burrs, dirt, etc., from hubs to allow master bearings to rotate freely.

TOOLS: D-346 (D-136) Master Differential Bearings (70-HD, 70-3HD)  
D-343 (D-117) Master Differential Bearings (70, 70-B, 70-U)



**Figure 4-45**

Assemble the differential bearing outboard spacers into the carrier housing, as removed in Figure 4-4.

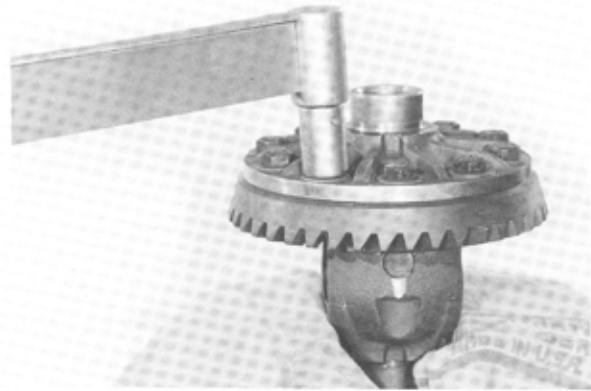
Assemble differential case into carrier (less ring gear). Mount dial indicator with a magnetic base as shown. Locate tip of indicator on flat surface of case. Force differential assembly as far as possible in the direction towards the indicator. With force still applied, set indicator at zero (0).

TOOLS: D-128 Dial Indicator Set

### NOTE

Dial indicator should have a minimum travel capability of .200 in. (5.08 mm).

Force the differential assembly as far as it will go in the opposite direction. Repeat these steps until you have obtained the same reading. Record the reading of the indicator on the worksheet, page 4-15. This reading will be measurement "A". After making sure the readings are correct, remove indicator and differential assembly from housing. Remove master bearings from hubs and set aside.



**Figure 4-46**

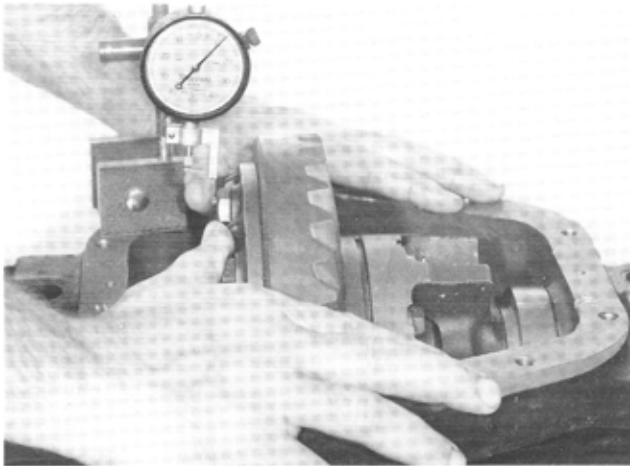
Place case assembly in a vise. Be sure flange face of the case is free of nicks or burrs. Assemble ring gear to case. Line up holes of the ring gear with those of the case. Use new ring gear screws. Draw up screws alternately and evenly. Torque ring gear screws to specification.

TOOL: Torque Wrench



**Figure 4-47**

Assemble master differential bearings onto case with I.D. chamber towards case. Place differential assembly into housing. Set up dial indicator as shown. Locate tip of indicator on flat surface of one of the ring gear screws. Force the differential case assembly (ring gear) away from the pinion gear. With force still applied to the differential case, set indicator at zero "0".



**Figure 4-48**

Force the differential case assembly and ring gear into mesh with the pinion gear. Rock ring gear to allow the teeth of the gear to mesh. Repeat until the same reading is obtained each time. Record this reading on the worksheet, page 4-15. This reading will be measurement "B". Remove indicator and differential case assembly from the carrier. Remove master differential bearings from the differential case. Refer to the worksheet for calculating ring gear backlash and differential bearing preload shims, page 4-15.



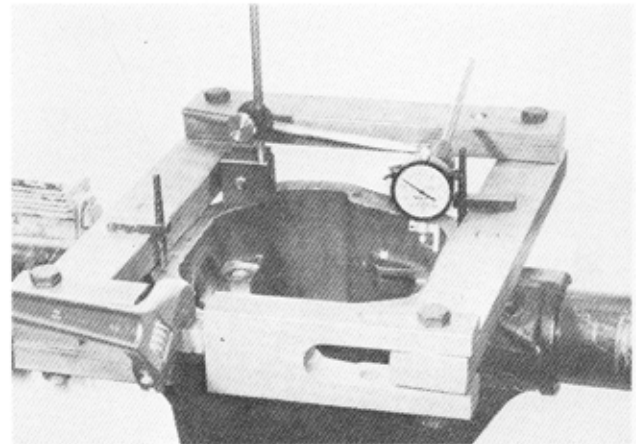
**Figure 4-49**

Assemble the required amount of shims onto hub (ring gear side) and opposite side as determined using the worksheet. Place bearing cone on hub of case. Use bearing installer to seat bearing cone as shown.

TOOLS: C-4025 Installer (70,70-B, 70-U)  
 C-4190 Installer (70-HD, 70-3HD)  
 C-4171 Universal Handle  
 DD-914-42 Button

**NOTE**

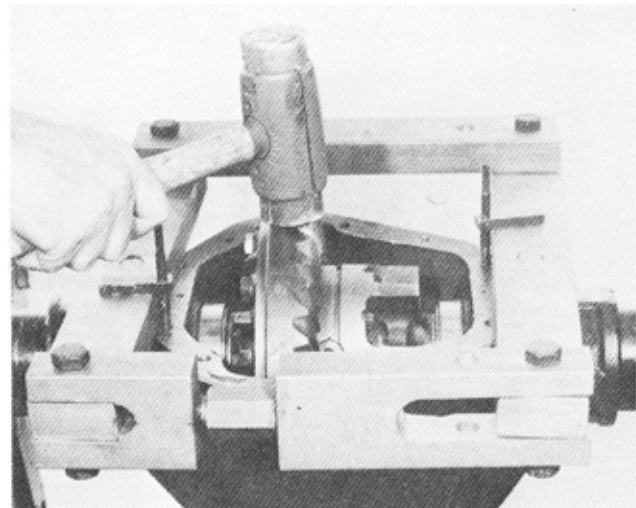
Button is used to raise case from bench to protect bearing cone cage from being damaged when installing opposite bearing cone.



**Figure 4-50**

Install spreader and indicator as shown. DO NOT SPREAD CARRIER OVER .015 in. (.38 mm). Remove indicator.

TOOLS: D-167 Spreader  
 D-128 Dial Indicator Set



**Figure 4-51**

Assemble differential bearing cups to differential bearing cones. Install differential assembly into carrier. Use a rawhide or plastic hammer to seat differential assembly into cross bores of carrier. Care should be taken to avoid nicking the teeth of the ring gear and pinion during assembly. Remove spreader.



## WORKSHEET FOR CALCULATING RING GEAR BACKLASH AND DIFFERENTIAL BEARING PRELOAD SHIMS

- (1) Total amount of space measured without ring gear as shown in Figure 4-45 Measurement A \_\_\_\_\_
- (2) Total amount of space measured with gear set assembled in carrier as shown in Figure 4-48 Measurement B \_\_\_\_\_
- (3) Measurement A minus Measurement B equals calculated Measurement C \_\_\_\_\_

After the measurements and calculations have been made, assemble the shim packs using the figures determined in A, B, & C, and adjusting the pack as described below.

### RING GEAR SIDE:

Assemble shim pack to measurement B.

### OPPOSITE SIDE OF RING GEAR:

Assemble shim pack to measurement C. Add .010 (.25 mm) for differential bearing preload and backlash.

## EXAMPLE

- (1) Total amount of space measured without ring gear as shown in Figure 4-45. Measurement A .105" (2.67 mm)
- (2) Total amount of space measured with gear set assembled in carrier as shown in Figure 4-48. Measurement B .065" (1.65 mm)
- (3) Measurement A minus Measurement B equals calculated Measurement C .040" (1.02 mm)

After the measurements and calculations have been made, assemble the shim packs using the figures determined in A, B, & C, and adjusting the pack as described below.

### RING GEAR SIDE:

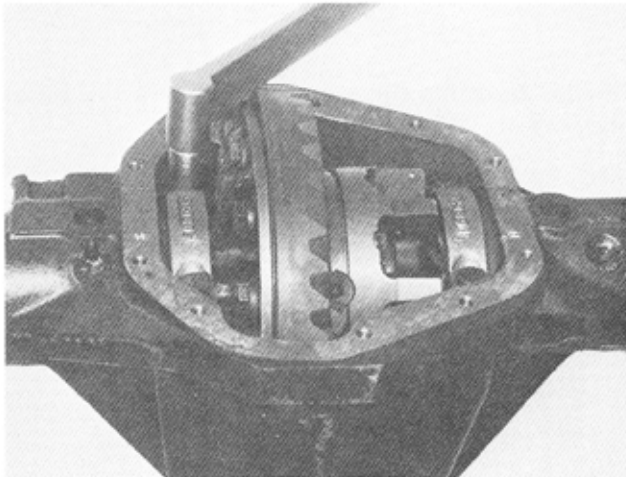
Assemble shim pack to measurement B. In this example it is .065" (1.65 mm).

### OPPOSITE SIDE OF RING GEAR:

Assemble shim pack to measurement C. Add .010 (.25 mm) for differential bearing preload and backlash.  $.040" + .010" = .050"$ , (1.02 mm + .25 mm = 1.27 mm).



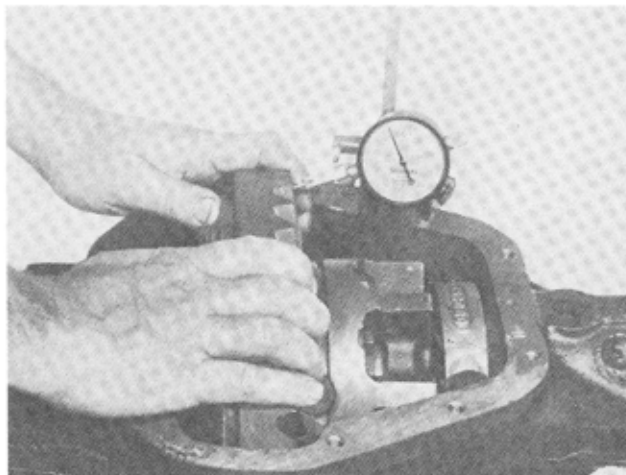
**WARNING:** When differential assembly is installed into carrier, use care to avoid pinching hand or fingers between differential bearing cup and carrier housing. Gear teeth may have sharp edges. When handling gear, use care to avoid cutting hands.



**Figure 4-52**

Install bearing caps. Make sure the letters stamped on the caps correspond with those on the carrier. Torque bearing cap screws to specification.

TOOLS: C-524-A Torque Wrench



**Figure 4-53**

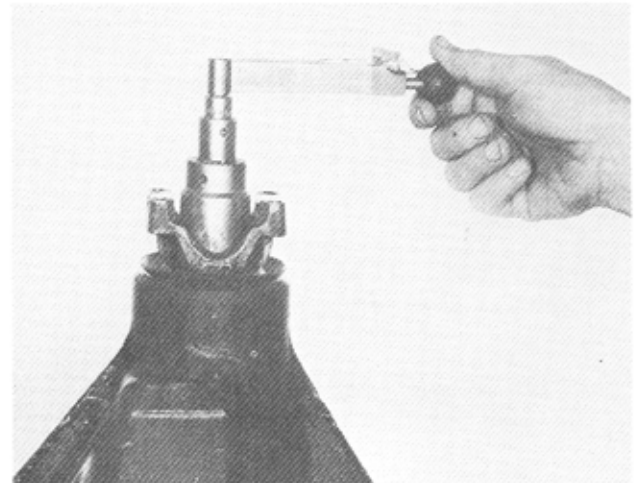
Check ring gear and pinion backlash in three equally spaced points with dial indicator as shown. Backlash should be within specification and should not vary more than .002 in. (.05 mm) between points checked.

TOOLS: D-128 Dial Indicator Set

High backlash is corrected by moving the ring gear closer to the pinion.

Low backlash is corrected by moving the ring gear away from the pinion.

These corrections are made by switching shims from one side of the differential case to the other.



**Figure 4-54**

Using an in. lb. torque wrench as shown, rotate pinion and differential assembly. Total torque reading should be within specification. If total preload is too high, remove an equal amount of shims from both sides of the differential case hubs. If total preload is too low, add an equal amount of shims to both sides of differential case hubs.

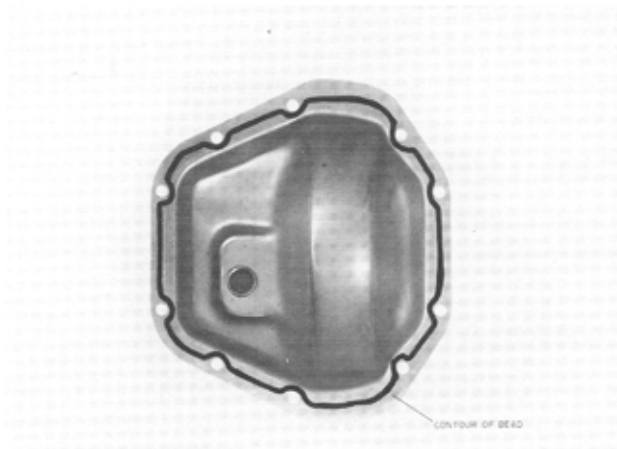
**NOTE**

If shims are added to, or removed from one side only, it will affect backlash reading.

**TORQUE TO ROTATE  
EXAMPLE FOR A  
4.10:1 GEAR SET:**

If the pinion torque to rotate is measured at 35 lbs. in (3.96 N•m), and additional differential bearing torque to rotate for a 4.10:1 is 6-8 lbs. in. (0.68-0.9 N•m); then the total torque to rotate should be 41-43 lbs. in. (4.63-4.86 N•m).

## APPLYING RTV SILICONE GASKET SEALER TO COVER PLATE



**Figure 4-55**

Apply gasket sealer to cover plate and assemble to carrier. Torque screws to specification.

TOOLS: C-524-A Torque Wrench

### NOTE

The cover face of the carrier and the flat surface of the cover plate must be free of any oil film or foreign material. Sealant material must meet specifications as described in the specification section of this manual.

Apply sealer to cover plate surface. Ensure that the sealer bead is laid on the inside of the cover screw holes. The bead is not to pass through the holes or outside of the holes.

The bead is to be  $\frac{1}{8}$ " to  $\frac{1}{4}$ " (3.18-6.35 mm) high and  $\frac{1}{8}$ " to  $\frac{1}{4}$ " (3.18-6.35 mm) wide.

Allow one hour cure time before filling carrier with the proper amount of specified lubricant and vehicle operation.

Assemble axle shafts and wheel end components. Refer to your vehicle service manual for proper wheel bearing endplay and torque specifications.

## SECTION 5 SPECIFICATIONS

### DIFFERENTIAL LUBRICATION

It is not our intent to recommend any particular brand or make of lubricant for the Spicer hypoid axle. However, an S.A.E. 80W-90 multi-purpose gear lubricant meeting Mil. Spec. L-2105-D, and suitable for <sup>1</sup>A.P.I., Service Classification GL-5, is suggested as a minimum requirement.

### LIMITED SLIP DIFFERENTIAL LUBRICATION

Limited Slip Differentials impose additional requirements on lubricants which may not be covered by the above specifications. Many vehicle manufacturers find it necessary to specify a special lubricant or limited slip additive for use with Limited Slip Differentials.

### WHEEL BEARING LUBRICATION

Wheel bearings are lubricated by packing with grease. For grease packing it is recommended that a <sup>2</sup>N.L.G.I. No. 2 lithium EP grease suitable for automotive wheel bearings be used. Contact your local vehicle service dealer or refer to your owner's manual for obtaining the proper lubricant specification, and maintenance schedule.

### CLOSED WHEEL END STEERING KNUCKLE LUBRICATION

The closed steering knuckle requires lubrication from a source other than the gear carrier assembly. Inboard tube seals contain the hypoid gear lube in the housing to provide adequate lubricant level for the gears, bearings, etc. This then requires an additional lubricant level to be maintained outboard, in each steering knuckle, which can be observed by removing fill plugs on each knuckle. Adequate level would be to the bottom of the fill plug hole, when vehicle is observed to be in a normal horizontal position.

A recommended lubricant is an S.A.E. 85W-140 grade, multi-purpose gear lubricant meeting the Mil.Spec. L-2105-D specification.

#### IMPORTANT

Motor vehicles are operated under various requirements, conditions, and environments. This manual specifies the minimum requirements that the lubricants should meet. However, it is recommended that the lubricants specified by the vehicle manufacturer be used. They may provide additional lubricating characteristics which may be required for your vehicle's operation. Contact your local service dealer or refer to your owner's manual for obtaining proper lubricant specification.

### AXLE LUBRICANT CHANGE SCHEDULE

The following schedule is a suggested lubricant change schedule. Lubricant in your vehicle may require more frequent changes depending on the environment in which it is operated. Contact your local authorized service dealer or refer to your owner's manual for obtaining the proper lubricant change schedule for your vehicle.

FOR NORMAL HIGHWAY USE change lubricant every 100,000 miles or 24 months, whichever comes first. FOR OFF HIGHWAY, SANDY, DUSTY OR WET CONDITIONS change lubricant every 25,000 miles or 6 months, whichever comes first. At each recommended engine oil change check axle fluid level and add if necessary. Do not overfill.

<sup>1</sup>A.P.I. - American Petroleum Institute

<sup>2</sup>N.L.G.I. - National Lubricating Grease Institute

## SUBMERSION OR DEEP WATER FORDING

If the vehicle is exposed to water deep enough to cover the hubs, it is recommended that the wheel ends be disassembled and inspected for water damage and/or contamination.

In the event the carrier housing should become submerged in water, particularly if over the breather, it is recommended that the hypoid gear lubricant be drained and internal parts be inspected for water damage and/or contamination.

Clean, examine, and replace damaged parts if necessary, prior to assembling the housing cover and refilling with the specified hypoid lubricant.

### NOTE

If the hubs are exposed to deep water, it is possible that the water could enter the carrier at the point the axle shaft enters the tube in the wheel end. This could also necessitate the draining of the hypoid lubricant as described above.

It is recommended that whenever bearings are removed, they be replaced with new ones, regardless of mileage.

## RTV SILICONE RUBBER SEALER SPECIFICATION

Refer to Vehicle Manufacturer's recommendation for proper RTV sealant.

## FASTENER STRENGTH IDENTIFICATION

### IMPORTANT

Whenever fasteners are replaced, it is very important that the fastener be replaced with one of equal or higher grade and quality. Fasteners should be torqued as recommended or specified for the application.

### WARNING

IF FASTENERS OF A LOWER GRADE OR CLASS ARE TORQUED TO THE REQUIREMENTS OF A HIGHER GRADE OR CLASS FASTENER, IT MAY RESULT IN COMPONENT FAILURE. (E.G. GRADE 5 FASTENER TORQUED TO THE REQUIREMENTS OF A GRADE 8 FASTENER.)



GRADE 5



GRADE 7



GRADE 8



SPECIAL GRADE  
(High Strength  
Applications)

Customary (Inch) Bolts - Identification marks correspond to bolt strength - Increasing numbers represent increasing strength.

Figure 5-1

Inch grade fasteners can be identified by the radial lines embossed upon the head of the fastener and will correspond to the fastener strength by two-lines less than actual grade (i.e. grade 8 fastener will display 6 radial lines on the head).

**NOTE**

Male and female threads should be dry and unlubricated (unless purchased new as such), clean and free from scale and dirt.

**WRENCH TIGHTENING TORQUE SPECIFICATIONS**

|   | Lbs. Ft. | N•m |
|---|----------|-----|
| Cover Screws                            | 35       | 48  |
| Differential Bearing Cap Screws         | 80       | 108 |
| Drive Pinion Nut                        | 260      | 353 |
| Cover Fill Plug                         | 25       | 34  |
| Grade 8 Ring Gear Screws                | 110      | 150 |
| Special Grade Ring Gear Screws          | 130      | 176 |
| Closed Ball Bearing Cap Screws and Nuts | 85       | 115 |
| Closed Ball Retainer Plate Screws       | 25       | 34  |
| Closed Ball Spindle Screws              | 80       | 108 |
| Closed Ball Knuckle Fill Plug           | 20       | 27  |
| Open Yoke King Pin                      | 550      | 746 |
| Open Yoke Bearing Cap Screws and Nuts   | 85       | 115 |
| Open Yoke Spindle Nuts                  | 60       | 81  |
| Differential Case Bolts                 | 70       | 95  |
| (Standard Two Piece Design)             |          |     |

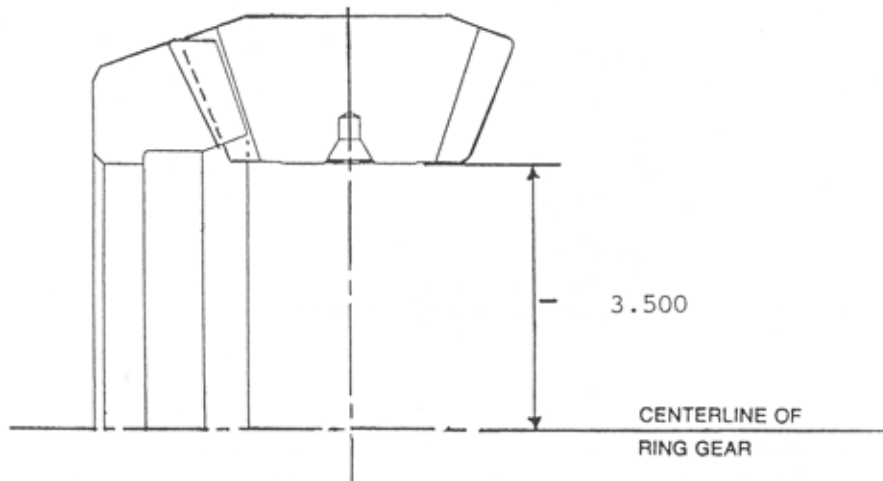
**PINION BEARING AND DIFFERENTIAL BEARING  
PRELOAD SPECIFICATION**

|  | Lbs. In. | N•m       |
|--|----------|-----------|
| Pinion Torque to Rotate (new bearings only)  | 20-40    | 2.26-4.52 |
| Additional Torque to Rotate Required for Differential<br>Bearing Preload (new bearings only) by Ratio: |          |           |
| 3.42:1 & 3.73:1  | 7-9      | 0.79-1.02 |
| 4.10:1 & 4.56:1  | 6-8      | 0.68-0.90 |
| 4.88:1 & 5.13:1  | 5-7      | 0.57-0.79 |
| 5.86:1 & 6.17:1  | 4-6      | 0.45-0.68 |
| 7.17:1   | 4-5      | 0.45-0.57 |

**BACKLASH SPECIFICATION**

Drive Gear to Drive Pinion ..... .005-.008 in. (.13-.20mm)

**DRIVE PINION GEAR DEPTH SPECIFICATION**



**Figure 5-2**

The pinion setting dimension is measured from the centerline of differential carrier (center line of ring gear) to face of pinion (button), plus or minus the etch on the button of the pinion. This dimension must be held within  $\pm .002$  in. (.05mm). For example: The Model 70 pinion setting dimension is 3.500 in. (88.9mm). If the pinion etch is a +2, this dimension becomes 3.502 in. (88.95mm).